

## CLIBOS



### BACKWARD CENTRIFUGAL PLUG FAN TYPE, DIRECT DRIVEN, FOR RECIRCULATION OF HOT GASES

#### MANUFACTURING FEATURES:

- Direct driven centrifugal medium pressure fan, type plug fan.
- Insulated casing made of carbon laminated steel, protected against corrosion by powder polyester coat. Finish C3.
- Thermal insulation with high density rock wool, 145Kg/m<sup>3</sup>, thickness 50mm
- Self-cleaning and reinforced impeller with high performance backward (reaction) blades made of carbon laminated steel dynamically balanced to minimize noise and vibrations painted in black heat-resistant paint coating.
- IE3 Motor for continuous operation (S1) Squirrel cage standardized asynchronous IEC motor with IP-55 protection and Class F electrical insulation. Standard voltages 230/400V 50Hz for three phase motors up to 4kW and 400/690V 50Hz for higher powers.
- Motor with flange (B5).
- Maximum continuous working temperature ambient (motor): 60°C.
- Suitable for transferring gases from -40°C to 250°C in continuous.
- Integrated cooling impeller

## Accessories



**CLBC**



**CLBI**



**INT**



**SFC**

#### APPLICATIONS:

Plug-type installation made for the recirculation of gases in:

- Ovens
- Boilers
- Paint booths
- Drying of tobacco, barley, ceramic, glass and wood leaves
- Insulated thermal cameras subjected to temperature control
- Burners and incinerators
- Melting furnaces

#### ON DEMAND:

- Fans for special voltages
- 2 Speed motor, Inox 304 or Inox 316
- Sparking proof construction
- Other sizes
- Other motors according to customer requirement

## Technical data

### Three-phase motor / 4 poles

Code	Model	R.P.M.	Rated I. A		Rated power kW	Max. Airflow m³/h	Sound db (A)**	Weight kg	Connect. diagram
			230V	400V					
CD4514905LGRR A1	CLIBOS 451 T4 1,1kW	1450	4,33	2,49	1,10	6.740	-	117	1
CD4544905LGRR A1	CLIBOS 454 T4 1,1kW	1450	4,33	2,49	1,10	8.750	58	119	1
CD5014125LGRR A1	CLIBOS 501 T4 2,2kW	1435	8,07	4,64	2,20	9.240	-	125	1
CD5044125LGRR A1	CLIBOS 504 T4 2,2kW	1435	8,07	4,64	2,20	12.010	61	128	1
CD5614105LGRR A1	CLIBOS 561 T4 3kW	1420	10,7	6,17	3,00	12.970	-	161	1
CD5644105LGRR A1	CLIBOS 564 T4 3kW	1420	10,7	6,17	3,00	16.850	65	164	1
CD6314135LGRR A1	CLIBOS 631 T4 5,5kW	1460	-	10,5	5,50	18.820	-	179	1
CD6344135LGRR A1	CLIBOS 634 T4 5,5kW	1460	-	10,5	5,50	24.460	68	183	1
CD7114165LGRR A1	CLIBOS 711 T4 11kW	1455	-	21,2	11,00	26.920	-	267	1
CD7144165LGRR A1	CLIBOS 714 T4 11kW	1455	-	21,2	11,00	35.110	73	272	1
CD8014185LGRR A1	CLIBOS 801 T4 18,5kW	1470	-	35,6	18,50	38.500	-	297	1
CD8044185LGRR A1	CLIBOS 804 T4 18,5kW	1470	-	35,6	18,50	50.190	76	303	1

### Three-phase motor / 6 poles

Code	Model	R.P.M.	Rated I. A		Rated power kW	Max. Airflow m³/h	Sound db (A)**	Weight kg	Connect. diagram
			230V	400V					
CD5016105LGRR A1	CLIBOS 501 T6 1,5kW	940	6,45	3,71	1,50	5.990	-	125	1
CD5046105LGRR A1	CLIBOS 504 T6 1,5kW	940	6,45	3,71	1,50	7.780	50	128	1
CD5616105LGRR A1	CLIBOS 561 T6 1,5kW	940	6,45	3,71	1,50	8.400	-	161	1
CD5646105LGRR A1	CLIBOS 564 T6 1,5kW	940	6,45	3,71	1,50	10.920	54	164	1
CD6316115LGRR A1	CLIBOS 631 T6 2,2kW	965	10,3	5,94	2,20	12.190	-	173	1

Code	Model	R.P.M.	Rated I. A		Rated power kW	Max. Airflow m <sup>3</sup> /h	Sound db (A)**	Weight kg	Connect. diagram
			230V	400V					
CD6346115LGRR A1	CLIBOS 634 T6 2,2kW	965	10,3	5,94	2,20	15.850	58	176	1
CD7116135LGRR A1	CLIBOS 711 T6 3kW	960	12,7	7,3	3,00	17.440	-	253	1
CD7146135LGRR A1	CLIBOS 714 T6 3kW	960	12,7	7,3	3,00	22.750	62	258	1
CD8016135LGRR A1	CLIBOS 801 T6 5,5kW	960	-	12,8	5,50	24.940	-	271	1
CD8046135LGRR A1	CLIBOS 804 T6 5,5kW	960	-	12,8	5,50	32.520	65	276	1

**Notes:**

\*\* Total sound pressure level at the point of maximum flow measured in dB(A) in the suction measured in free field at a distance of 6m from the source

## Dimensions

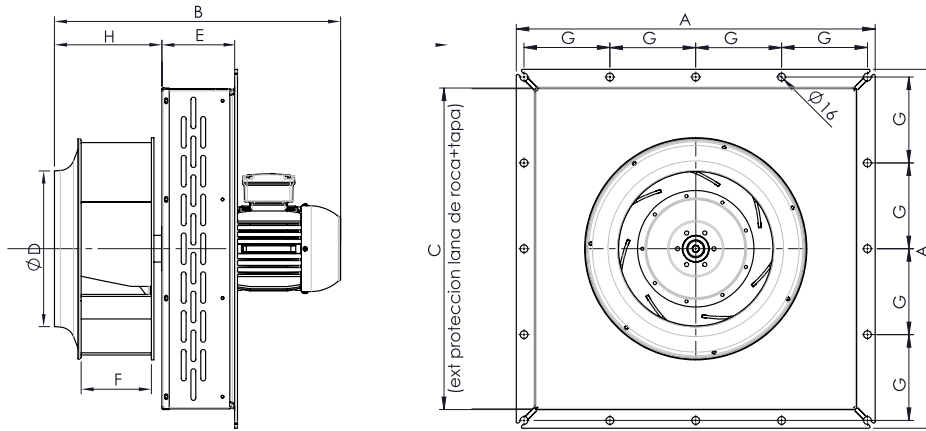

Model	A	C	D	E	F	G	H	$\pm B$
CLIBOS 451 T4 1,1kW	740	663	321	150	129	177	219.5	580
CLIBOS 454 T4 1,1kW	740	663	321	150	177	177	251.5	580
CLIBOS 501 T4 2,2kW	740	645	359	150	143	177	247	669.1
CLIBOS 501 T6 1,5kW	740	645	359	150	143	177	247	669.1
CLIBOS 504 T4 2,2kW	740	645	359	150	196	177	282	580
CLIBOS 504 T6 1,5kW	740	645	359	150	196	177	282	580
CLIBOS 561 T4 3kW	801	723	399	150	160	192	271.5	695.6
CLIBOS 561 T6 1,5kW	801	723	399	150	160	192	271.5	695.6
CLIBOS 564 T4 3kW	801	723	399	150	220	192	311.5	580
CLIBOS 564 T6 1,5kW	801	723	399	150	220	192	311.5	580
CLIBOS 631 T4 5,5kW	801	723	448	150	180	192	307.5	786.2
CLIBOS 631 T6 2,2kW	801	723	448	150	180	192	304.5	746.6
CLIBOS 634 T4 5,5kW	801	723	448	150	248	192	352.5	580
CLIBOS 634 T6 2,2kW	801	723	448	150	248	192	352.5	580
CLIBOS 711 T4 11kW	970	873	502	150	203	233	342.5	938.75
CLIBOS 711 T6 3kW	970	873	502	150	203	233	340.5	819.2
CLIBOS 714 T4 11kW	970	873	502	150	279	233	393.5	580
CLIBOS 714 T6 3kW	970	873	502	150	279	233	393.5	580
CLIBOS 801 T4 18,5kW	970	873	570.5	150	229	233	379.5	1041.1
CLIBOS 801 T6 5,5kW	970	873	570.5	150	229	233	378.5	857.2
CLIBOS 804 T4 18,5kW	970	873	570.5	150	314	233	380	580
CLIBOS 804 T6 5,5kW	970	873	570.5	150	314	233	380	580

# Wiring diagram

## Wiring diagram N° 1

230/400V

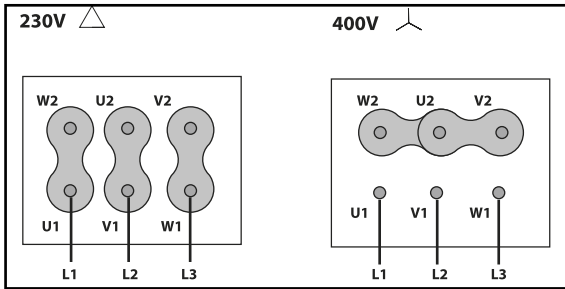

400/690V

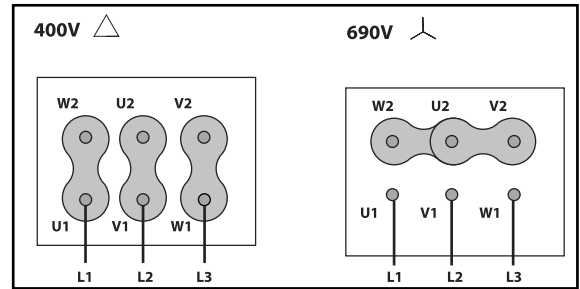

# CHARACTERISTIC CURVE

1	CLIBOS 451 T4 1,1kW	2	CLIBOS 454 T4 1,1kW	3	CLIBOS 501 T4 2,2kW	4	CLIBOS 504 T4 2,2kW
5	CLIBOS 561 T4 3kW	6	CLIBOS 564 T4 3kW	7	CLIBOS 631 T4 5,5kW	8	CLIBOS 634 T4 5,5kW
9	CLIBOS 711 T4 11kW	10	CLIBOS 714 T4 11kW	11	CLIBOS 801 T4 18,5kW	12	CLIBOS 804 T4 18,5kW

## AIR FLOW - PRESSURE

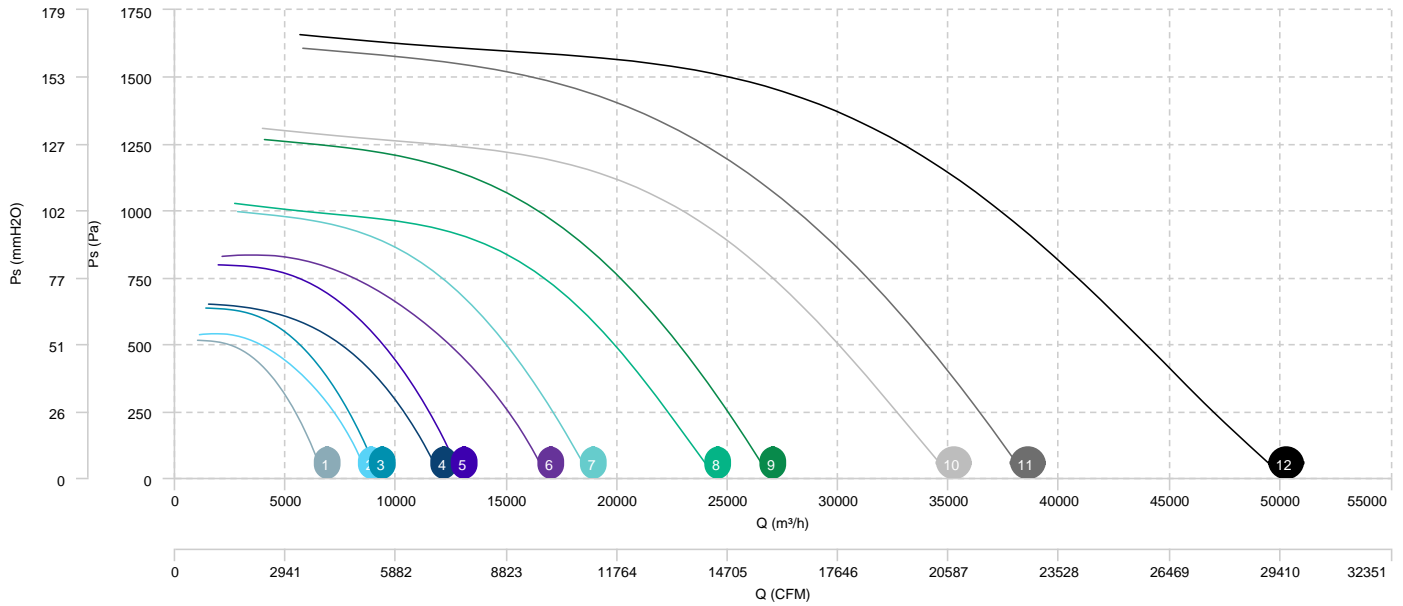

## AIR FLOW - ABSORBED POWER

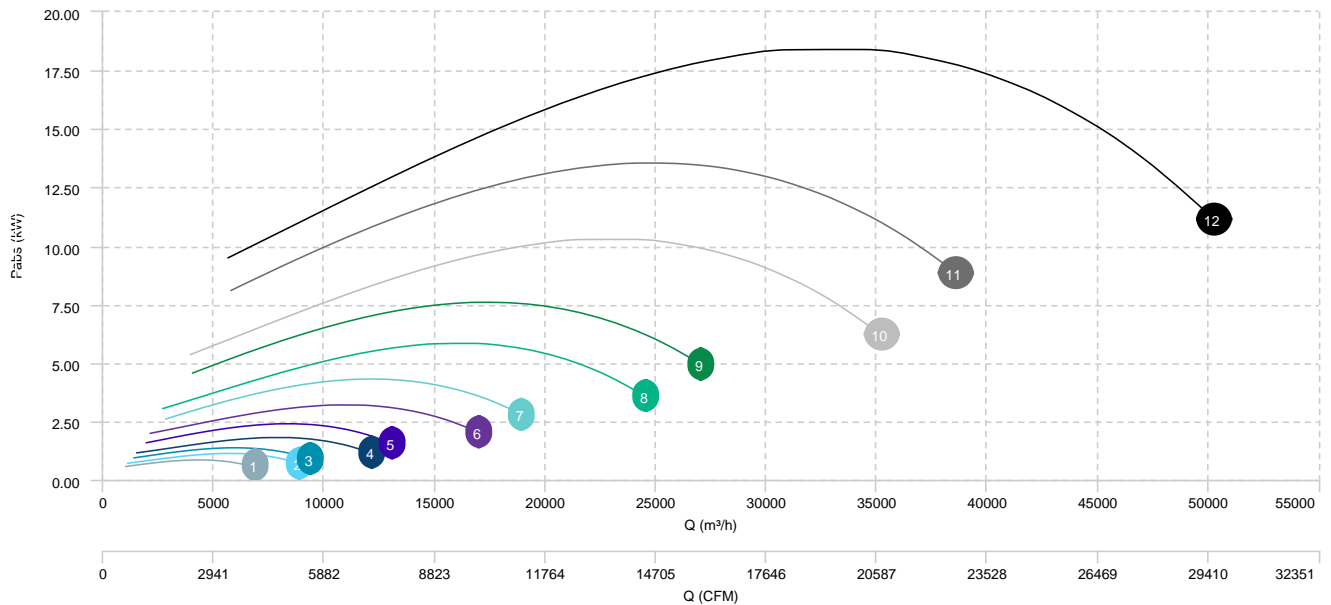

1	CLIBOS 501 T6 1,5kW	2	CLIBOS 504 T6 1,5kW	3	CLIBOS 561 T6 1,5kW	4	CLIBOS 564 T6 1,5kW
5	CLIBOS 631 T6 2,2kW	6	CLIBOS 634 T6 2,2kW	7	CLIBOS 711 T6 3kW	8	CLIBOS 714 T6 3kW
9	CLIBOS 801 T6 5,5kW	10	CLIBOS 804 T6 5,5kW				

**AIR FLOW - PRESSURE**

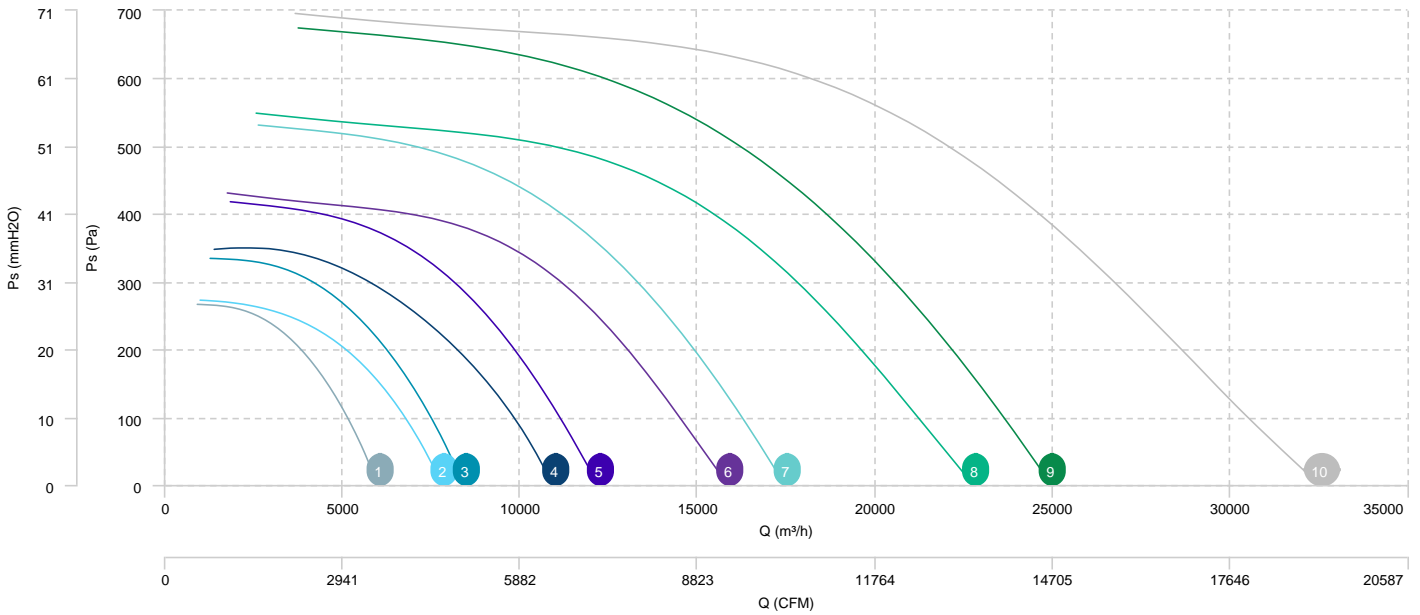

**AIR FLOW - ABSORBED POWER**

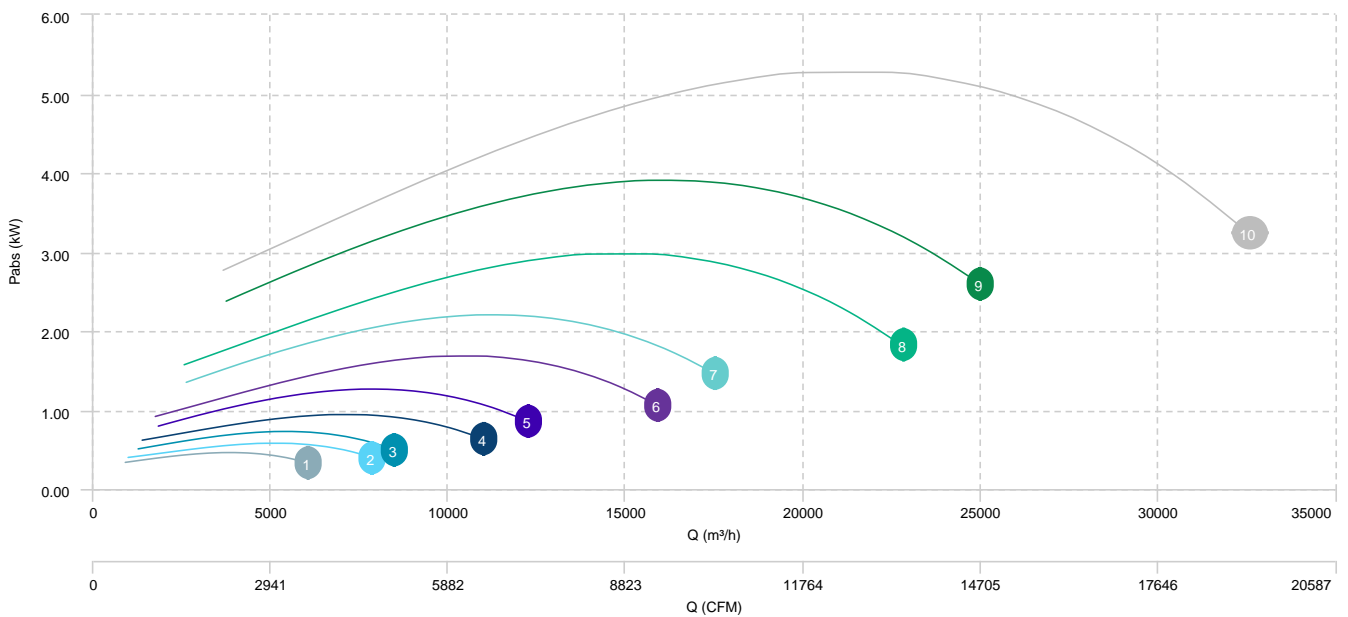

## Sound data

### Sound / 4 poles

Sound power Lw dB (A)										
Model		63 Hz	125 Hz	250 Hz	500 Hz	1000 Hz	2000 Hz	4000 Hz	8000 Hz	Total
CLIBOS 451 T4 1,1kW	Radiated	37	55	62	68	70	77	63	55	79
CLIBOS 454 T4 1,1kW	Inlet	62	70	74	77	79	77	74	71	84
	Radiated	36	59	63	67	70	77	64	57	78
CLIBOS 501 T4 2,2kW	Radiated	41	58	65	71	73	80	67	58	82
CLIBOS 504 T4 2,2kW	Inlet	65	73	77	81	82	80	77	74	87
	Radiated	40	62	66	71	73	80	67	60	82
CLIBOS 561 T4 3kW	Radiated	61	65	72	77	80	77	65	61	83
CLIBOS 564 T4 3kW	Inlet	68	76	81	84	85	83	80	77	91
	Radiated	66	69	76	80	82	79	69	62	86
CLIBOS 631 T4 5,5kW	Radiated	66	69	76	81	84	82	69	65	88
CLIBOS 634 T4 5,5kW	Inlet	72	80	84	88	89	87	84	81	94
	Radiated	70	74	80	85	86	83	73	66	90
CLIBOS 711 T4 11kW	Radiated	69	73	80	85	87	85	73	68	91
CLIBOS 714 T4 11kW	Inlet	77	85	89	92	94	92	89	86	99
	Radiated	73	77	83	88	90	87	76	70	94
CLIBOS 801 T4 18,5kW	Radiated	73	76	84	88	91	89	76	72	95
CLIBOS 804 T4 18,5kW	Inlet	80	88	92	95	97	95	92	89	102
	Radiated	77	81	87	92	94	90	80	73	98

### Sound / 6 poles

Sound power Lw dB (A)										
Model		63 Hz	125 Hz	250 Hz	500 Hz	1000 Hz	2000 Hz	4000 Hz	8000 Hz	Total
CLIBOS 501 T6 1,5kW	Radiated	31	48	55	61	63	71	57	49	72
CLIBOS 504 T6 1,5kW	Inlet	54	62	67	70	71	69	66	63	76
	Radiated	30	53	56	61	63	70	58	51	72
CLIBOS 561 T6 1,5kW	Radiated	51	55	62	67	70	67	55	51	73
CLIBOS 564 T6 1,5kW	Inlet	57	65	70	73	74	73	69	67	80
	Radiated	56	59	66	71	72	69	59	52	76
CLIBOS 631 T6 2,2kW	Radiated	56	59	66	71	74	72	59	55	78
CLIBOS 634 T6 2,2kW	Inlet	61	69	74	77	78	76	73	70	84
	Radiated	60	64	70	75	76	73	63	56	80
CLIBOS 711 T6 3kW	Radiated	59	63	70	75	78	75	63	58	81



Sound power Lw dB (A)

Model		63 Hz	125 Hz	250 Hz	500 Hz	1000 Hz	2000 Hz	4000 Hz	8000 Hz	Total
CLIBOS 714 T6 3kW	Inlet	66	74	78	82	83	81	78	75	88
	Radiated	64	67	73	78	80	77	67	60	84
CLIBOS 801 T6 5,5kW	Radiated	63	66	74	78	81	79	66	62	85
CLIBOS 804 T6 5,5kW	Inlet	69	77	81	85	86	84	81	78	91
	Radiated	67	71	77	82	84	81	70	64	88