

## CIKSTORM

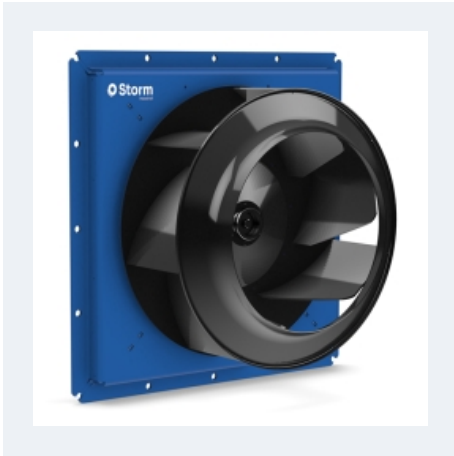

### REACTION CENTRIFUGAL FAN PLUG FOR INDUSTRIAL APPLICATIONS

#### MANUFACTURING FEATURES

- Centrifugal fan of medium pressure direct coupling type plug fan.
- Square frame made of carbon laminated steel, protected against corrosion by coating C3 finished paint.
- Self-cleaning turbine and reinforced impeller of high performance backward blades made of carbon laminated steel dynamically balanced to minimize noise and vibrations. C3 black paint.
- IE3 motor for continuous operation (S1). Standardized asynchronous squirrel cage motor with IP-55 protection and class F electrical isolation. Standard voltages 230/400V 50Hz for three-phase motors up to 4kW and 400/690V 50Hz for higher powers.
- Motor with flange (B5) and airtight shaft.
- Maximum continuous working temperature: ambient (motor): 60°C.
- Suitable for transferring gases from -40°C to 120°C continuously.

#### APPLICATIONS

Plug fan installation for gas recirculation in:

- Integrated in Machinery
- Paint booths
- Dryers of tobacco leaves, barley, ceramics, glass, wood
- Odor control in industry
- Indoor / outdoor pollution control
- Clean air drive and renewal
- Big buildings
- Malls
- Factories / Industrial buildings
- Warehouses
- Manufacture and treatment of chemical products.

#### UNDER REQUEST

- Fans for special voltages
- Refrigeration roll
- 2 speed motor
- C5 corrosion protection
- Anti-caloric paint
- Inox 304
- Inox 316
- Spark construction
- Other construction sizes
- Other motors according to customer requirements

## Accessories



CLBC



CLBI



INT



SFC

## Technical data

### Three-phase motor / 4 poles

Code	Model	R.P.M.	Rated I. A		Rated power kW	Max. Airflow m <sup>3</sup> /h	Sound db (A)**	Weight kg	Connect. diagram
			230V	400V					
PF4514905LG	CIKSTORM 451 T4 1,1kW	1450	4,33	2,49	1,10	6.740	-	99	1
PF4544905LG	CIKSTORM 454 T4 1,1kW	1450	4,33	2,49	1,10	8.750	58	101	1
PF5014125LG	CIKSTORM 501 T4 2,2kW	1435	8,07	4,64	2,20	9.240	-	105	1
PF5044125LG	CIKSTORM 504 T4 2,2kW	1435	8,07	4,64	2,20	12.010	61	108	1
PF5614105LG	CIKSTORM 561 T4 3kW	1420	10,7	6,17	3,00	12.970	-	139	1
PF5644105LG	CIKSTORM 564 T4 3kW	1420	10,7	6,17	3,00	16.850	65	142	1
PF6314135LG	CIKSTORM 631 T4 5,5kW	1460	-	10,5	5,50	18.820	-	154	1
PF6344135LG	CIKSTORM 634 T4 5,5kW	1460	-	10,5	5,50	24.460	68	158	1
PF7114165LG	CIKSTORM 711 T4 11kW	1455	-	21,2	11,00	26.920	-	239	1
PF7144165LG	CIKSTORM 714 T4 11kW	1455	-	21,2	11,00	35.110	73	244	1
PF8014185LG	CIKSTORM 801 T4 18,5kW	1470	-	35,6	18,50	38.500	-	265	1
PF8044185LG	CIKSTORM 804 T4 18,5kW	1470	-	35,6	18,50	50.190	76	271	1

### Three-phase motor / 6 poles

Code	Model	R.P.M.	Rated I. A		Rated power kW	Max. Airflow m <sup>3</sup> /h	Sound db (A)**	Weight kg	Connect. diagram
			230V	400V					
PF5016105LG	CIKSTORM 501 T6 1,5kW	940	6,45	3,71	1,50	5.990	-	105	1
PF5046105LG	CIKSTORM 504 T6 1,5kW	940	6,45	3,71	1,50	7.780	50	108	1
PF5616105LG	CIKSTORM 561 T6 1,5kW	940	6,45	3,71	1,50	8.400	-	139	1
PF5646105LG	CIKSTORM 564 T6 1,5kW	940	6,45	3,71	1,50	10.920	54	142	1
PF6316115LG	CIKSTORM 631 T6 2,2kW	965	10,3	5,94	2,20	12.190	-	148	1
PF6346115LG	CIKSTORM 634 T6 2,2kW	965	10,3	5,94	2,20	15.850	58	151	1
PF7116135LG	CIKSTORM 711 T6 3kW	960	12,7	7,3	3,00	17.440	-	225	1
PF7146135LG	CIKSTORM 714 T6 3kW	960	12,7	7,3	3,00	22.750	62	230	1
PF8016135LG	CIKSTORM 801 T6 5,5kW	960	-	12,8	5,50	24.940	-	239	1
PF8046135LG	CIKSTORM 804 T6 5,5kW	960	-	12,8	5,50	32.520	65	244	1

**Notes:**

\*\* Total sound pressure level at the point of maximum flow measured in dB(A) in the suction measured in free field at a distance of 6m from the source

## Dimensions

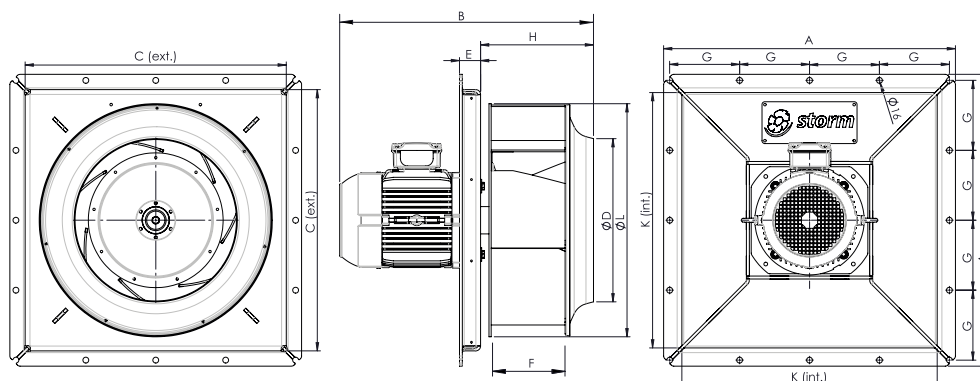

Model	A	C	D	E	F	G	H	K	L
CIKSTORM 451 T4 1,1kW	740	657	321	58	129	177	219.5	645	458
CIKSTORM 454 T4 1,1kW	740	657	321	58	177	177	251.5	645	458
CIKSTORM 501 T4 2,2kW	740	657	359	58	143	177	247	645	508
CIKSTORM 501 T6 1,5kW	740	657	359	58	143	177	247	645	508
CIKSTORM 504 T4 2,2kW	740	657	359	58	196	177	282	645	508
CIKSTORM 504 T6 1,5kW	740	657	359	58	196	177	282	645	508
CIKSTORM 561 T4 3kW	801	717	399	58	160	192	271.5	701	568
CIKSTORM 561 T6 1,5kW	801	717	399	58	160	192	271.5	701	568
CIKSTORM 564 T4 3kW	801	717	399	58	220	192	311.5	701	568
CIKSTORM 564 T6 1,5kW	801	717	399	58	220	192	311.5	701	568
CIKSTORM 631 T4 5,5kW	801	717	448	58	180	192	307.5	701	640
CIKSTORM 631 T6 2,2kW	801	717	448	58	180	192	304.5	701	640
CIKSTORM 634 T4 5,5kW	801	717	448	58	248	192	352.5	701	640
CIKSTORM 634 T6 2,2kW	801	717	448	58	248	192	352.5	701	640
CIKSTORM 711 T4 11kW	970	867	502	58	203	233	342.5	851	720
CIKSTORM 711 T6 3kW	970	867	502	58	203	233	340.5	851	720
CIKSTORM 714 T4 11kW	970	867	502	58	279	233	393.5	851	720
CIKSTORM 714 T6 3kW	970	867	502	58	279	233	393.5	851	720
CIKSTORM 801 T4 18,5kW	970	867	570.5	58	229	233	379.5	851	810
CIKSTORM 801 T6 5,5kW	970	867	570.5	58	229	233	378.5	851	810
CIKSTORM 804 T4 18,5kW	970	867	570.5	58	314	233	436	851	810
CIKSTORM 804 T6 5,5kW	970	867	570.5	58	314	233	436	851	810

Model	±B
CIKSTORM 451 T4 1,1kW	530

<b>Model</b>	<b>±B</b>
CIKSTORM 454 T4 1,1kW	530
CIKSTORM 501 T4 2,2kW	619.1
CIKSTORM 501 T6 1,5kW	619.1
CIKSTORM 504 T4 2,2kW	530
CIKSTORM 504 T6 1,5kW	530
CIKSTORM 561 T4 3kW	645.6
CIKSTORM 561 T6 1,5kW	645.6
CIKSTORM 564 T4 3kW	530
CIKSTORM 564 T6 1,5kW	530
CIKSTORM 631 T4 5,5kW	736.2
CIKSTORM 631 T6 2,2kW	696.6
CIKSTORM 634 T4 5,5kW	530
CIKSTORM 634 T6 2,2kW	530
CIKSTORM 711 T4 11kW	888.75
CIKSTORM 711 T6 3kW	769.2
CIKSTORM 714 T4 11kW	530
CIKSTORM 714 T6 3kW	530
CIKSTORM 801 T4 18,5kW	991
CIKSTORM 801 T6 5,5kW	807.2
CIKSTORM 804 T4 18,5kW	530
CIKSTORM 804 T6 5,5kW	530

# Wiring diagram

## Wiring diagram N° 1

230/400V

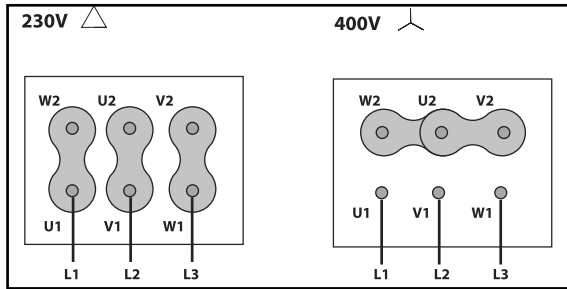

400/690V

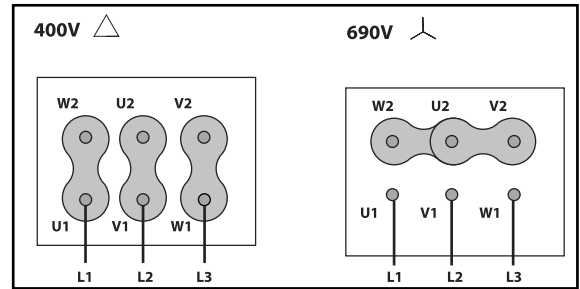

## CHARACTERISTIC CURVE

1	CIKSTORM 451 T4 1,1kW	2	CIKSTORM 454 T4 1,1kW	3	CIKSTORM 501 T4 2,2kW	4	CIKSTORM 504 T4 2,2kW
5	CIKSTORM 561 T4 3kW	6	CIKSTORM 564 T4 3kW	7	CIKSTORM 631 T4 5,5kW	8	CIKSTORM 634 T4 5,5kW
9	CIKSTORM 711 T4 11kW	10	CIKSTORM 714 T4 11kW	11	CIKSTORM 801 T4 18,5kW	12	CIKSTORM 804 T4 18,5kW

### AIR FLOW - PRESSURE

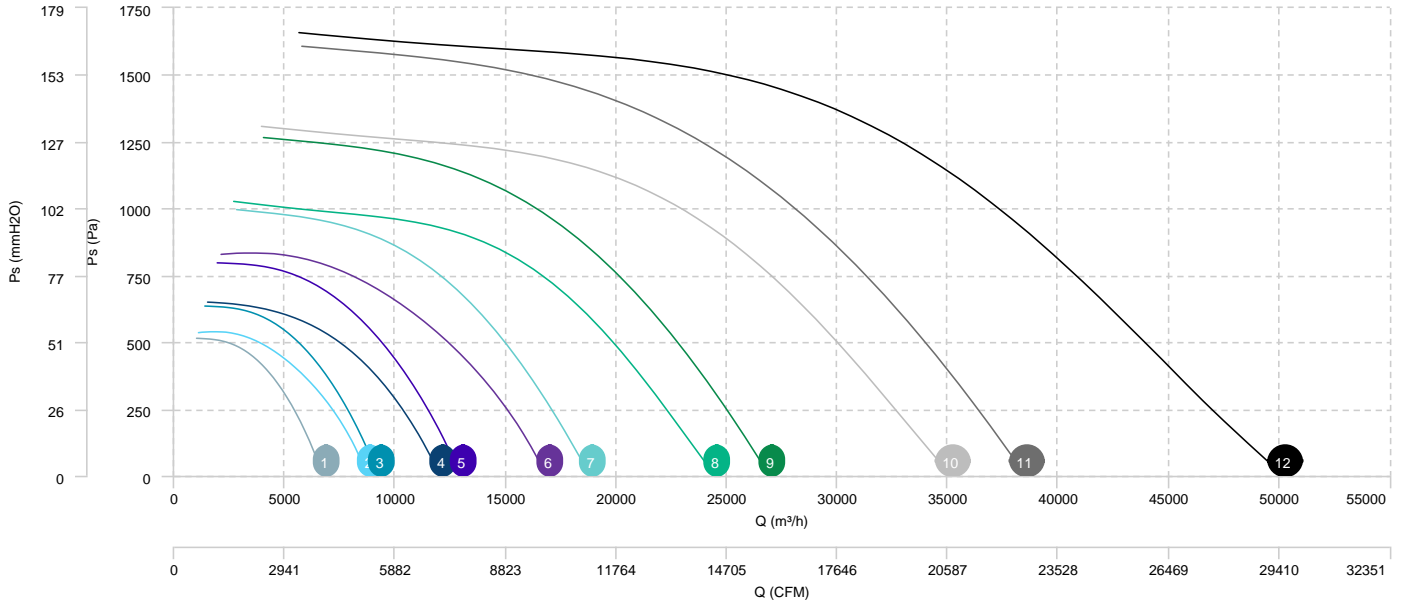

### AIR FLOW - ABSORBED POWER

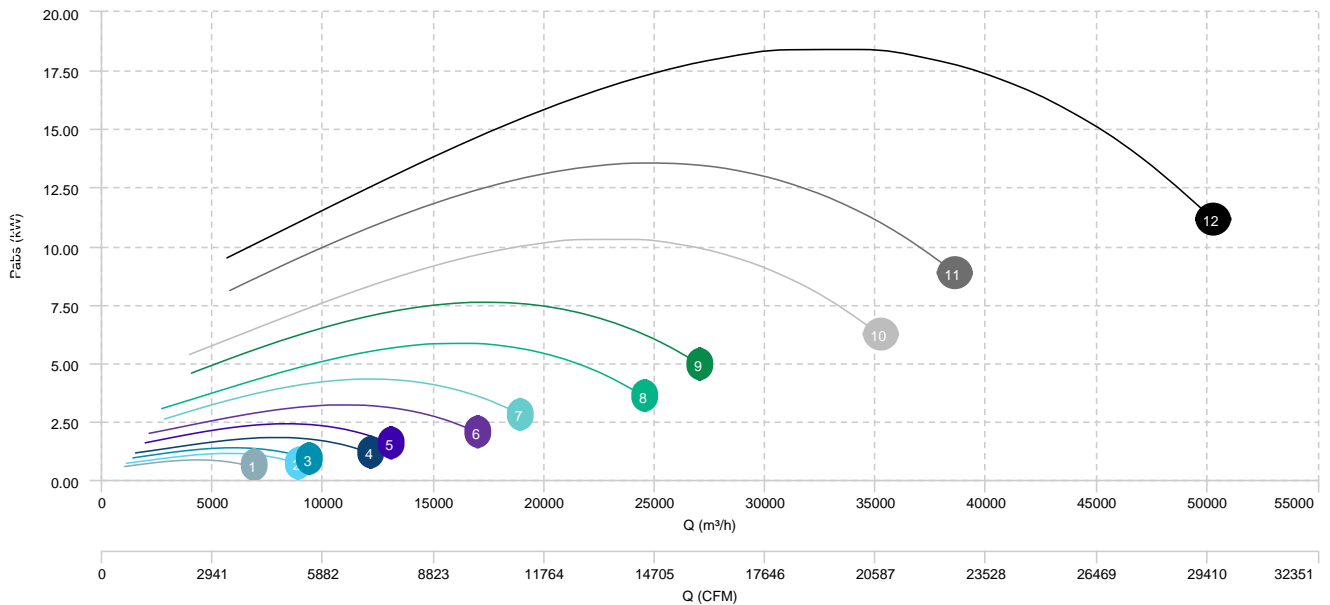

1	CIKSTORM 501 T6 1,5kW	2	CIKSTORM 504 T6 1,5kW	3	CIKSTORM 561 T6 1,5kW	4	CIKSTORM 564 T6 1,5kW
5	CIKSTORM 631 T6 2,2kW	6	CIKSTORM 634 T6 2,2kW	7	CIKSTORM 711 T6 3kW	8	CIKSTORM 714 T6 3kW
9	CIKSTORM 801 T6 5,5kW	10	CIKSTORM 804 T6 5,5kW				

**AIR FLOW - PRESSURE**

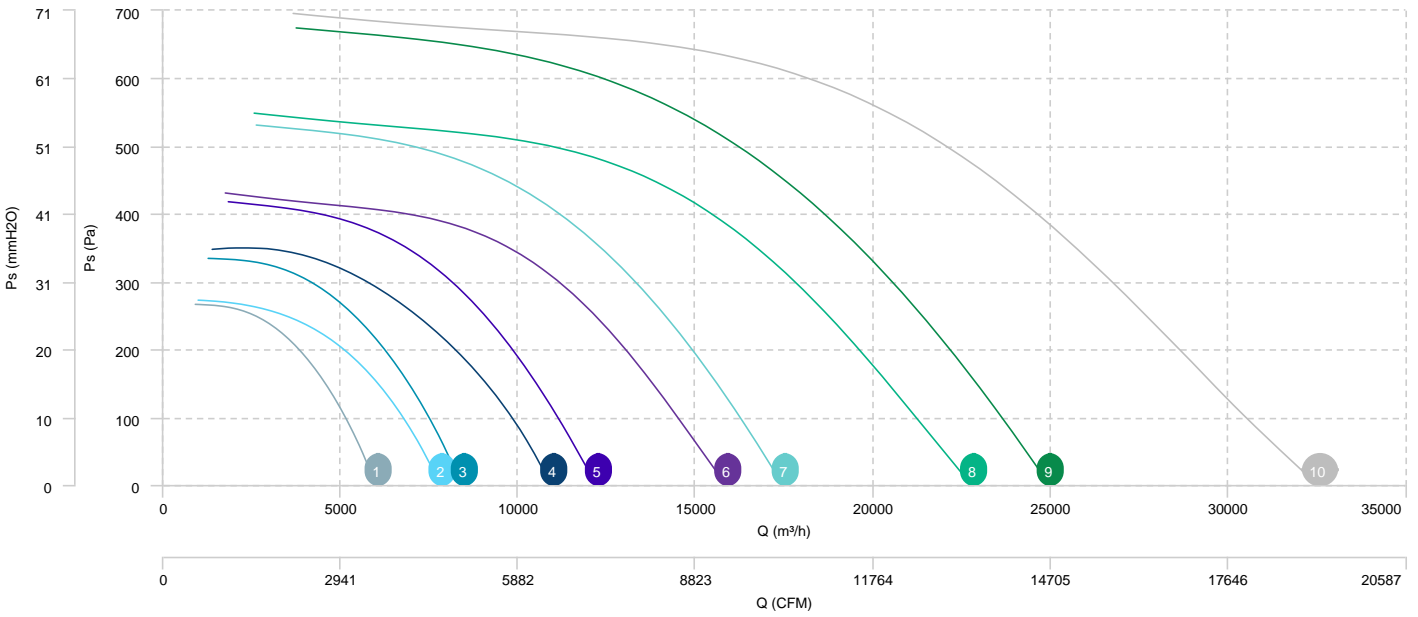

**AIR FLOW - ABSORBED POWER**

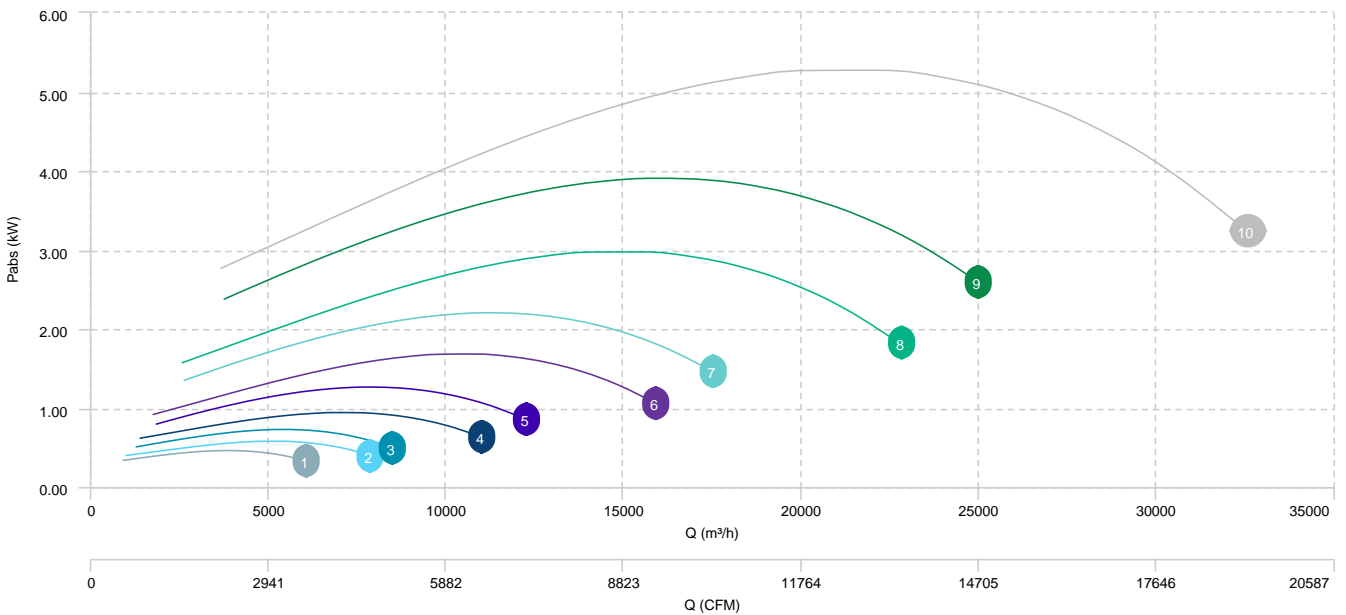

## Sound data

### Sound / 4 poles

Sound power Lw dB (A)										
Model		63 Hz	125 Hz	250 Hz	500 Hz	1000 Hz	2000 Hz	4000 Hz	8000 Hz	Total
CIKSTORM 451 T4 1,1kW	Radiated	37	55	62	68	70	77	63	55	79
CIKSTORM 454 T4 1,1kW	Inlet	62	70	74	77	79	77	74	71	84
	Radiated	36	59	63	67	70	77	64	57	78
CIKSTORM 501 T4 2,2kW	Radiated	41	58	65	71	73	80	67	58	82
CIKSTORM 504 T4 2,2kW	Inlet	65	73	77	81	82	80	77	74	87
	Radiated	40	62	66	71	73	80	67	60	82
CIKSTORM 561 T4 3kW	Radiated	61	65	72	77	80	77	65	61	83
CIKSTORM 564 T4 3kW	Inlet	68	76	81	84	85	83	80	77	91
	Radiated	66	69	76	80	82	79	69	62	86
CIKSTORM 631 T4 5,5kW	Radiated	66	69	76	81	84	82	69	65	88
CIKSTORM 634 T4 5,5kW	Inlet	72	80	84	88	89	87	84	81	94
	Radiated	70	74	80	85	86	83	73	66	90
CIKSTORM 711 T4 11kW	Radiated	69	73	80	85	87	85	73	68	91
CIKSTORM 714 T4 11kW	Inlet	77	85	89	92	94	92	89	86	99
	Radiated	73	77	83	88	90	87	76	70	94
CIKSTORM 801 T4 18,5kW	Radiated	73	76	84	88	91	89	76	72	95
CIKSTORM 804 T4 18,5kW	Inlet	80	88	92	95	97	95	92	89	102
	Radiated	77	81	87	92	94	90	80	73	98

### Sound / 6 poles

Sound power Lw dB (A)										
Model		63 Hz	125 Hz	250 Hz	500 Hz	1000 Hz	2000 Hz	4000 Hz	8000 Hz	Total
CIKSTORM 501 T6 1,5kW	Radiated	31	48	55	61	63	71	57	49	72
CIKSTORM 504 T6 1,5kW	Inlet	54	62	67	70	71	69	66	63	76
	Radiated	30	53	56	61	63	70	58	51	72
CIKSTORM 561 T6 1,5kW	Radiated	51	55	62	67	70	67	55	51	73
CIKSTORM 564 T6 1,5kW	Inlet	57	65	70	73	74	73	69	67	80
	Radiated	56	59	66	71	72	69	59	52	76
CIKSTORM 631 T6 2,2kW	Radiated	56	59	66	71	74	72	59	55	78
CIKSTORM 634 T6 2,2kW	Inlet	61	69	74	77	78	76	73	70	84
	Radiated	60	64	70	75	76	73	63	56	80
CIKSTORM 711 T6 3kW	Radiated	59	63	70	75	78	75	63	58	81



Sound power Lw dB (A)

Model		63 Hz	125 Hz	250 Hz	500 Hz	1000 Hz	2000 Hz	4000 Hz	8000 Hz	Total
CIKSTORM 714 T6 3kW	Inlet	66	74	78	82	83	81	78	75	88
	Radiated	64	67	73	78	80	77	67	60	84
CIKSTORM 801 T6 5,5kW	Radiated	63	66	74	78	81	79	66	62	85
CIKSTORM 804 T6 5,5kW	Inlet	69	77	81	85	86	84	81	78	91
	Radiated	67	71	77	82	84	81	70	64	88