

## SBC-3 PLUS FILTER EEC

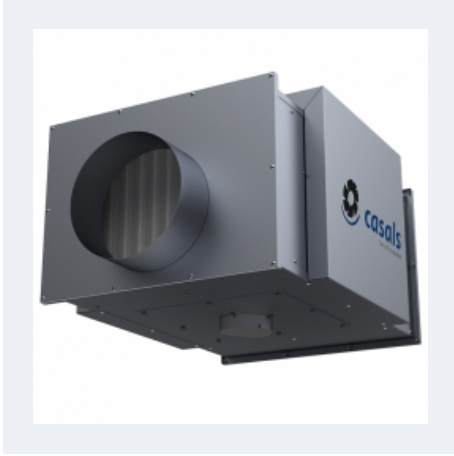

### CENTRIFUGAL FAN IN SOUNDPROOF LOW PROFILE BOX WITH CIRCULAR FLANGES AND FILTER(S), WITH EXTERNAL ROTOR EC MOTOR

#### MANUFACTURING FEATURES

Inline ventilation box made of galvanized steel with circular connection flanges. 40mm thick rock wool insulation.

Self-cleaning impeller with back curved (reaction) blades of high performance and single inlet, direct driven. Dynamically balanced to minimize noise and vibrations. Polyamide reinforced impeller for models 125, 150 and 160 and aluminum plate for the rest.

High efficiency, low noise external rotor EC motor. Speed control through a 0-10V or PWM signal. Single-phase 230V 50/60Hz power supply for models 125 to 355 and three-phase 400V 50/60Hz for sizes 400 and 560. IP44 motor and class B insulation.

Supplied with a filtration stage ISO COARSE 65% (G4) or 2 stages ISO COARSE 65% (G4) and ISO ePM1 65% (F7).

Easily accessible inspection and cleaning register.

### Accessories



CFF



CFGF



CHEF



INT



PMR



REGC



TEJ  
SB-3

#### APPLICATIONS

Designed for installation in ducts, they are indicated for:

- Air renovations in bathrooms and small rooms.
- Perfect for false ceiling mounting.

Working temperature range from -20°C to 60°C.

## Technical data

### Single-phase motor

Code	Model	R.P.M.	Rated I. A 230V	Rated power kW	Max. Airflow m <sup>3</sup> /h	Sound db (A)**	Weight kg	Connect. diagram
SBCP3125ECG4	SBC-3 PLUS FILTER (ISO Coarse≥60%) 125 EEC	3950	0,25	0,06	320	-	10	1
SBCP3150ECG4	SBC-3 PLUS FILTER (ISO Coarse≥60%) 150 EEC	3570	0,73	0,10	525	-	15,50	1
SBCP3160ECG4	SBC-3 PLUS FILTER (ISO Coarse≥60%) 160 EEC	3570	0,73	0,10	570	-	15,50	1
SBCP3200ECG4	SBC-3 PLUS FILTER (ISO Coarse≥60%) 200 EEC	2500	1,00	0,15	1.060	-	23	1
SBCP3250ECG4	SBC-3 PLUS FILTER (ISO Coarse≥60%) 250 EEC	2500	1,00	0,15	1.340	-	23	1
SBCP3315ECG4	SBC-3 PLUS FILTER (ISO Coarse≥60%) 315 EEC	2500	1,00	0,15	1.480	-	23	1
SBCP3355ECG4	SBC-3 PLUS FILTER (ISO Coarse≥60%) 355 EEC	2350	1,7	0,36	2.600	-	34,50	2
SBCP3125ECG4F7	SBC-3 PLUS FILTER (ISO Coarse≥60%+ePM1≥50%) 125 EEC	3950	0,25	0,06	255	-	12	1
SBCP3150ECG4F7	SBC-3 PLUS FILTER (ISO Coarse≥60%+ePM1≥50%) 150 EEC	3570	0,73	0,10	455	-	19,50	1
SBCP3160ECG4F7	SBC-3 PLUS FILTER (ISO Coarse≥60%+ePM1≥50%) 160 EEC	3570	0,73	0,10	490	-	19,50	1
SBCP3200ECG4F7	SBC-3 PLUS FILTER (ISO Coarse≥60%+ePM1≥50%) 200 EEC	2500	1,00	0,15	880	-	29	1
SBCP3250ECG4F7	SBC-3 PLUS FILTER (ISO Coarse≥60%+ePM1≥50%) 250 EEC	2500	1,00	0,15	1.050	-	29	1
SBCP3315ECG4F7	SBC-3 PLUS FILTER (ISO Coarse≥60%+ePM1≥50%) 315 EEC	2500	1,00	0,15	1.115	-	29	1
SBCP3355ECG4F7	SBC-3 PLUS FILTER (ISO Coarse≥60%+ePM1≥50%) 355 EEC	2350	1,7	0,36	2.180	-	42,50	2

### Three-phase motor

Code	Model	R.P.M.	Rated I. A 400V	Rated power kW	Max. Airflow m <sup>3</sup> /h	Sound db (A)**	Weight kg	Connect. diagram
SBCP3400ECG4	SBC-3 PLUS FILTER (ISO Coarse≥60%) 400 EEC	2100	1,63	0,99	3.925	-	57	3
SBCP3450ECG4	SBC-3 PLUS FILTER (ISO Coarse≥60%) 450 EEC	2100	1,63	0,99	4.580	-	57	3
SBCP3500ECG4	SBC-3 PLUS FILTER (ISO Coarse≥60%) 500 EEC	1450	1,67	1,01	5.450	-	78	3
SBCP3560ECG4	SBC-3 PLUS FILTER (ISO Coarse≥60%) 560 EEC	1450	1,67	1,01	5.620	-	78	3
SBCP3400ECG4F 7	SBC-3 PLUS FILTER (ISO Coarse≥60%+ePM1≥50%) 400 EEC	2100	1,63	0,99	3.420	-	67	3
SBCP3450ECG4F 7	SBC-3 PLUS FILTER (ISO Coarse≥60%+ePM1≥50%) 450 EEC	2100	1,63	0,99	3.950	-	67	3
SBCP3500ECG4F 7	SBC-3 PLUS FILTER (ISO Coarse≥60%+ePM1≥50%) 500 EEC	1450	1,67	1,01	4.770	-	90	3
SBCP3560ECG4F 7	SBC-3 PLUS FILTER (ISO Coarse≥60%+ePM1≥50%) 560 EEC	1450	1,67	1,01	4.930	-	90	3

**Notes:**

\*\* Total sound pressure level at the point of maximum flow measured in dB(A) in the suction measured in free field at a distance of 6m from the source

## Dimensions

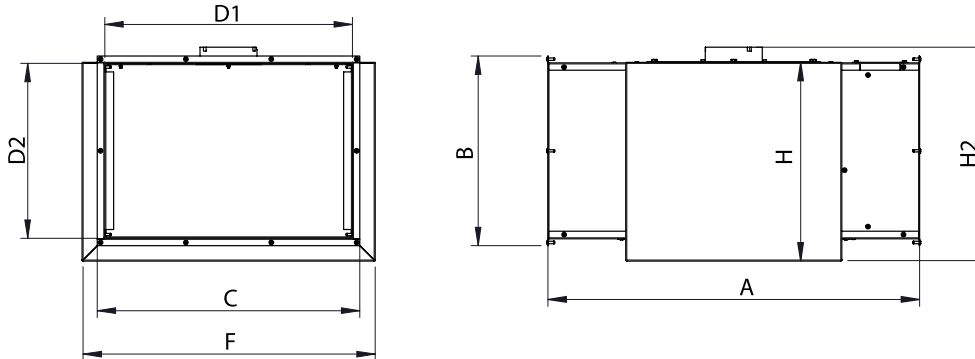

Model	A	B	C	D	D1	D2	E	F	H
SBC-3 PLUS FILTER (ISO Coarse≥60%) 125 EEC	522	184	334	125	300	150	98	392	199
SBC-3 PLUS FILTER (ISO Coarse≥60%) 150 EEC	622	234	434	150	400	200	98	492	249
SBC-3 PLUS FILTER (ISO Coarse≥60%) 160 EEC	622	234	434	160	400	200	98	492	249
SBC-3 PLUS FILTER (ISO Coarse≥60%) 200 EEC	752	387	534	200	500	353	98	592	402
SBC-3 PLUS FILTER (ISO Coarse≥60%) 250 EEC	752	387	534	250	500	353	98	592	402
SBC-3 PLUS FILTER (ISO Coarse≥60%) 315 EEC	752	387	534	315	500	353	98	592	402
SBC-3 PLUS FILTER (ISO Coarse≥60%) 355 EEC	902	434	634	355	600	400	98	693	450
SBC-3 PLUS FILTER (ISO Coarse≥60%) 400 EEC	1052	534	734	400	700	500	98	793	550
SBC-3 PLUS FILTER (ISO Coarse≥60%) 450 EEC	1052	534	734	450	700	500	98	793	550
SBC-3 PLUS FILTER (ISO Coarse≥60%) 500 EEC	1352	635	834	500	800	601	98	893	651
SBC-3 PLUS FILTER (ISO Coarse≥60%) 560 EEC	1352	635	834	560	800	601	98	893	651
SBC-3 PLUS FILTER (ISO Coarse≥60%+ePM1≥50%) 125 EEC	522	184	334	125	300	150	98	392	199
SBC-3 PLUS FILTER (ISO Coarse≥60%+ePM1≥50%) 150 EEC	622	234	434	150	400	200	98	492	249
SBC-3 PLUS FILTER (ISO Coarse≥60%+ePM1≥50%) 160 EEC	622	234	434	160	400	200	98	492	249

Model	A	B	C	D	D1	D2	E	F	H
SBC-3 PLUS FILTER (ISO Coarse≥60%+ePM1≥50%) 200 EEC	752	387	534	200	500	353	98	592	402
SBC-3 PLUS FILTER (ISO Coarse≥60%+ePM1≥50%) 250 EEC	752	387	534	250	500	353	98	592	402
SBC-3 PLUS FILTER (ISO Coarse≥60%+ePM1≥50%) 315 EEC	752	387	534	315	500	353	98	592	402
SBC-3 PLUS FILTER (ISO Coarse≥60%+ePM1≥50%) 355 EEC	902	434	634	355	600	400	98	693	450
SBC-3 PLUS FILTER (ISO Coarse≥60%+ePM1≥50%) 400 EEC	1052	534	734	400	700	500	98	793	550
SBC-3 PLUS FILTER (ISO Coarse≥60%+ePM1≥50%) 450 EEC	1052	534	734	450	700	500	98	793	550
SBC-3 PLUS FILTER (ISO Coarse≥60%+ePM1≥50%) 500 EEC	1352	635	834	500	800	601	98	893	651
SBC-3 PLUS FILTER (ISO Coarse≥60%+ePM1≥50%) 560 EEC	1352	635	834	560	800	601	98	893	651

Model	H2
SBC-3 PLUS FILTER (ISO Coarse≥60%) 125 EEC	225
SBC-3 PLUS FILTER (ISO Coarse≥60%) 150 EEC	274.5
SBC-3 PLUS FILTER (ISO Coarse≥60%) 160 EEC	274.5
SBC-3 PLUS FILTER (ISO Coarse≥60%) 200 EEC	431
SBC-3 PLUS FILTER (ISO Coarse≥60%) 250 EEC	431
SBC-3 PLUS FILTER (ISO Coarse≥60%) 315 EEC	431
SBC-3 PLUS FILTER (ISO Coarse≥60%) 355 EEC	491
SBC-3 PLUS FILTER (ISO Coarse≥60%) 400 EEC	605
SBC-3 PLUS FILTER (ISO Coarse≥60%) 450 EEC	605
SBC-3 PLUS FILTER (ISO Coarse≥60%) 500 EEC	706
SBC-3 PLUS FILTER (ISO Coarse≥60%) 560 EEC	706
SBC-3 PLUS FILTER (ISO Coarse≥60%+ePM1≥50%) 125 EEC	225
SBC-3 PLUS FILTER (ISO Coarse≥60%+ePM1≥50%) 150 EEC	274.5
SBC-3 PLUS FILTER (ISO Coarse≥60%+ePM1≥50%) 160 EEC	274.5

Model	H2
SBC-3 PLUS FILTER (ISO Coarse $\geq$ 60%+ePM1 $\geq$ 50%) 200 EEC	431
SBC-3 PLUS FILTER (ISO Coarse $\geq$ 60%+ePM1 $\geq$ 50%) 250 EEC	431
SBC-3 PLUS FILTER (ISO Coarse $\geq$ 60%+ePM1 $\geq$ 50%) 315 EEC	431
SBC-3 PLUS FILTER (ISO Coarse $\geq$ 60%+ePM1 $\geq$ 50%) 355 EEC	491
SBC-3 PLUS FILTER (ISO Coarse $\geq$ 60%+ePM1 $\geq$ 50%) 400 EEC	605
SBC-3 PLUS FILTER (ISO Coarse $\geq$ 60%+ePM1 $\geq$ 50%) 450 EEC	605
SBC-3 PLUS FILTER (ISO Coarse $\geq$ 60%+ePM1 $\geq$ 50%) 500 EEC	706
SBC-3 PLUS FILTER (ISO Coarse $\geq$ 60%+ePM1 $\geq$ 50%) 560 EEC	706

## Wiring diagram

### Wiring diagram N° 1

Nº	Signal Señal	Colour Color	Specification Especificación
1	L	Brown Marrón	AC 220V/50Hz
2	N	Blue Azul	AC 220V/50Hz
3	Pe	Yellow-Green Amarillo-Verde	

Nº	Signal Señal	Colour Color	Specification Especificación
1	GND	Blue Azul	
2	Vsp	Yellow Amarillo	0-10 V/PWM
3	Vcc	Red Rojo	DC 10V
4	FG	White Blanco	1 Pulse/R

### Wiring diagram N° 2

Nº	Signal Señal	Colour Color	Specification Especificación
1	L	Brown Marrón	AC 220V-50/60 Hz
2	N	Blue Azul	AC 220V-50/60 Hz
3	Pe	Yellow-Green Amarillo-Verde	

Nº	Signal Señal	Colour Color	Specification Especificación
1	GND	Blue Azul	
2	Vsp	Yellow Amarillo	0-10 V/PWM
3	Vcc	Red Rojo	DC 10V
4	FG	White Blanco	12 Pulse/R

**Wiring diagram N° 3**

Nº	Signal Señal	Colour Color	Specification Especificación
1	L1	Black Negro	AC380V-50/60Hz
2	L2	Black Negro	AC380V-50/60Hz
3	L3	Black Negro	AC380V-50/60Hz
4	Pe	Yellow-Green Amarillo-Verde	

Nº	Signal Señal	Colour Color	Specification Especificación
1	Vcc	Red Rojo	DC10V
2	Vsp	Yellow Amarillo	0-10VDC/PWM
3	GND	Blue Azul	
4	FG	White Blanco	12 Pulse/R



# CHARACTERISTIC CURVE

SBC-3 PLUS FILTER (ISO Coarse $\geq$ 60%) 125 EEC

## AIR FLOW - PRESSURE

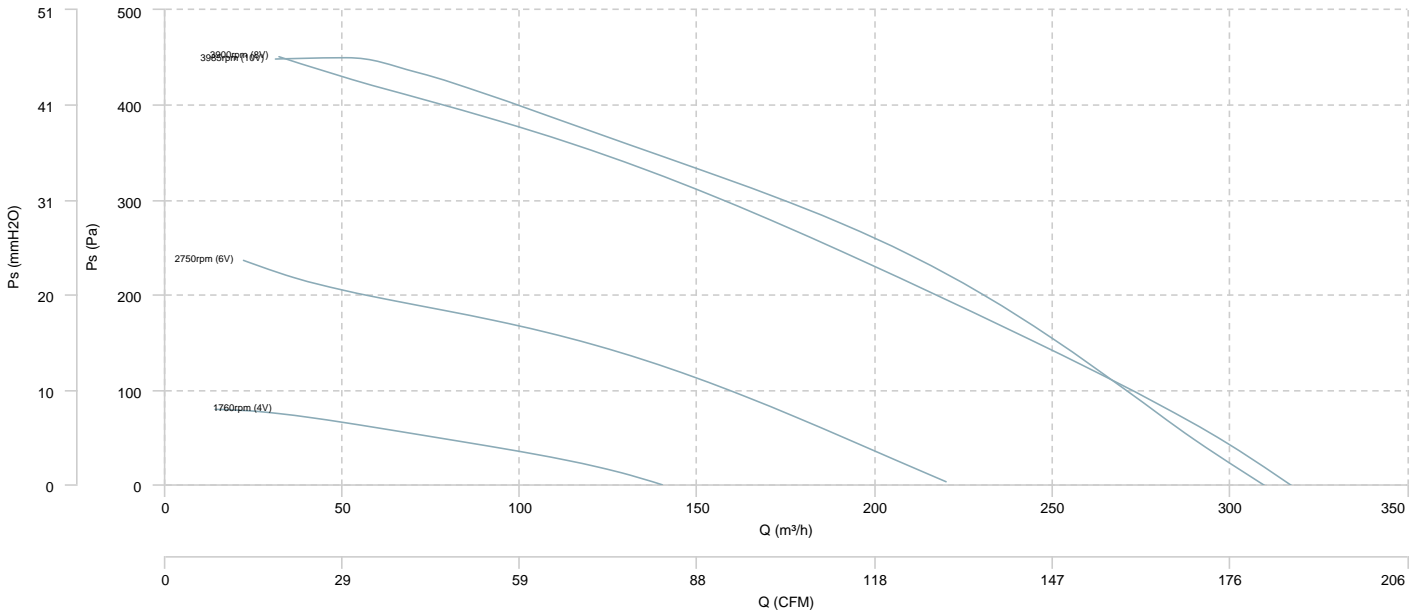

## AIR FLOW - MECHANICAL POWER

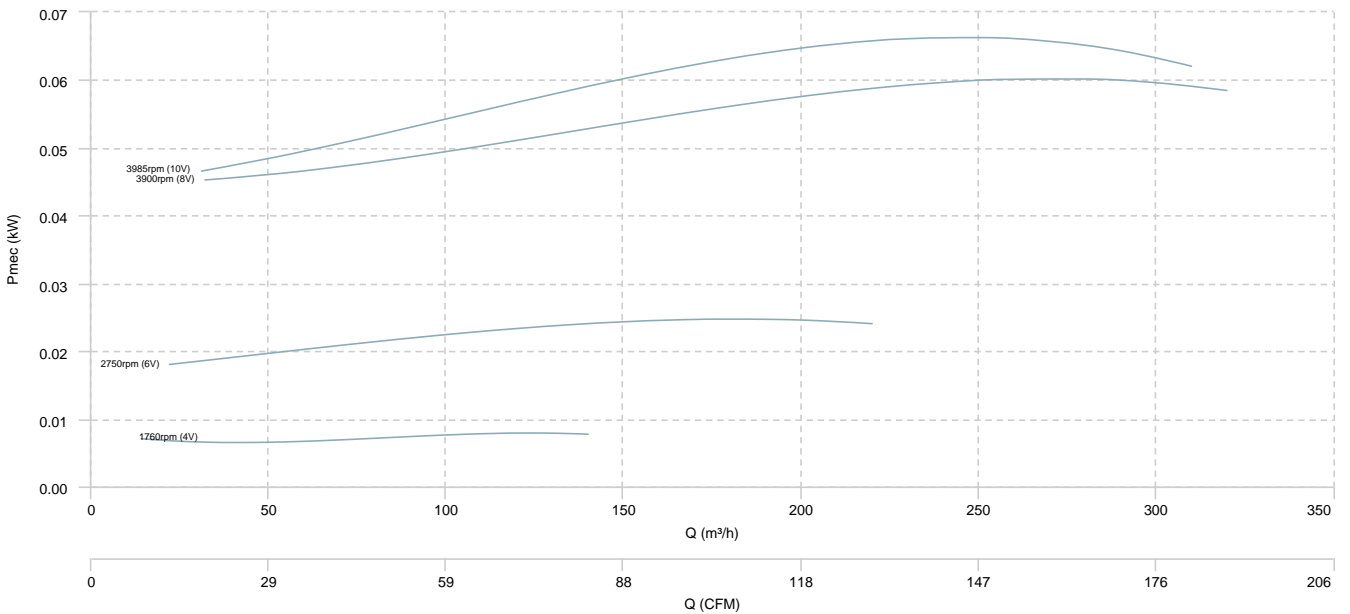

SBC-3 PLUS FILTER (ISO Coarse $\geq$ 60%) 150 EEC

**AIR FLOW - PRESSURE**

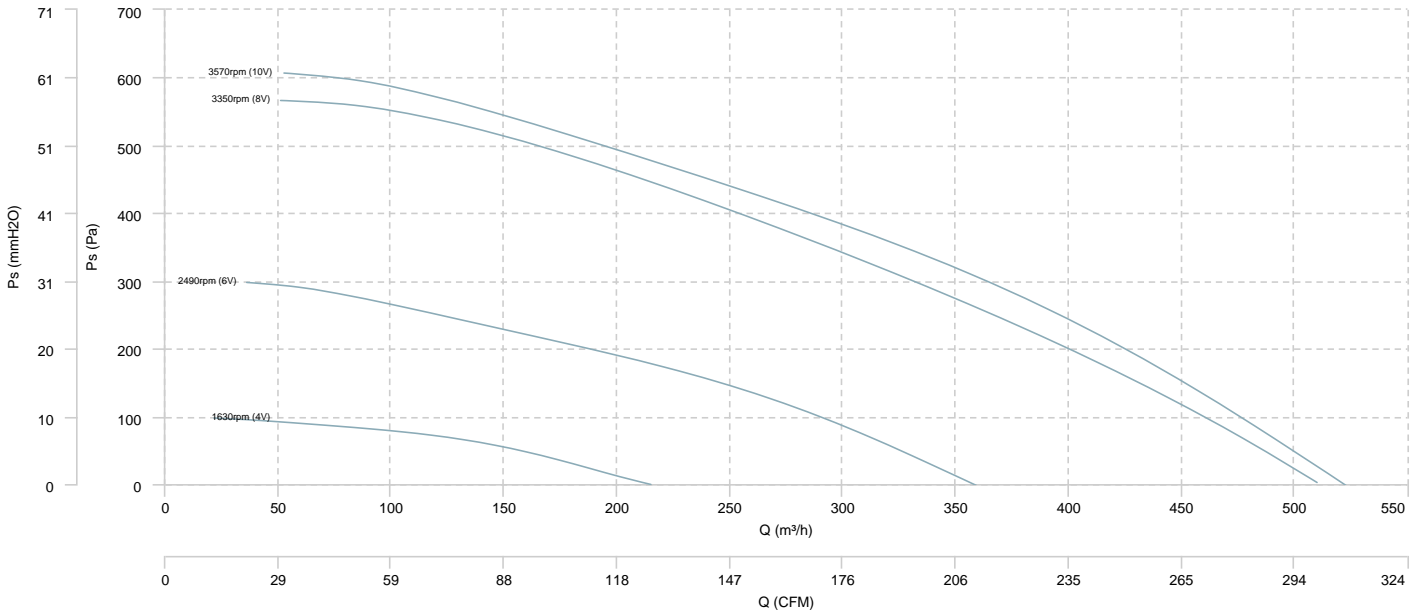

**AIR FLOW - MECHANICAL POWER**

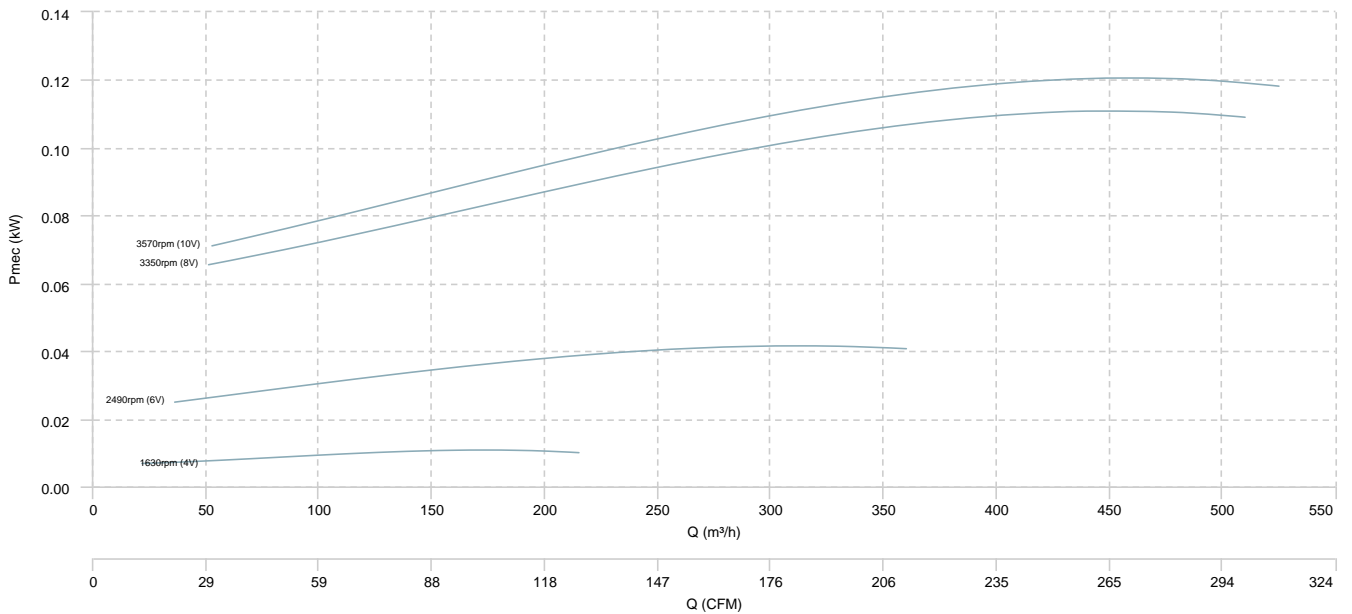

SBC-3 PLUS FILTER (ISO Coarse $\geq$ 60%) 160 EEC

**AIR FLOW - PRESSURE**

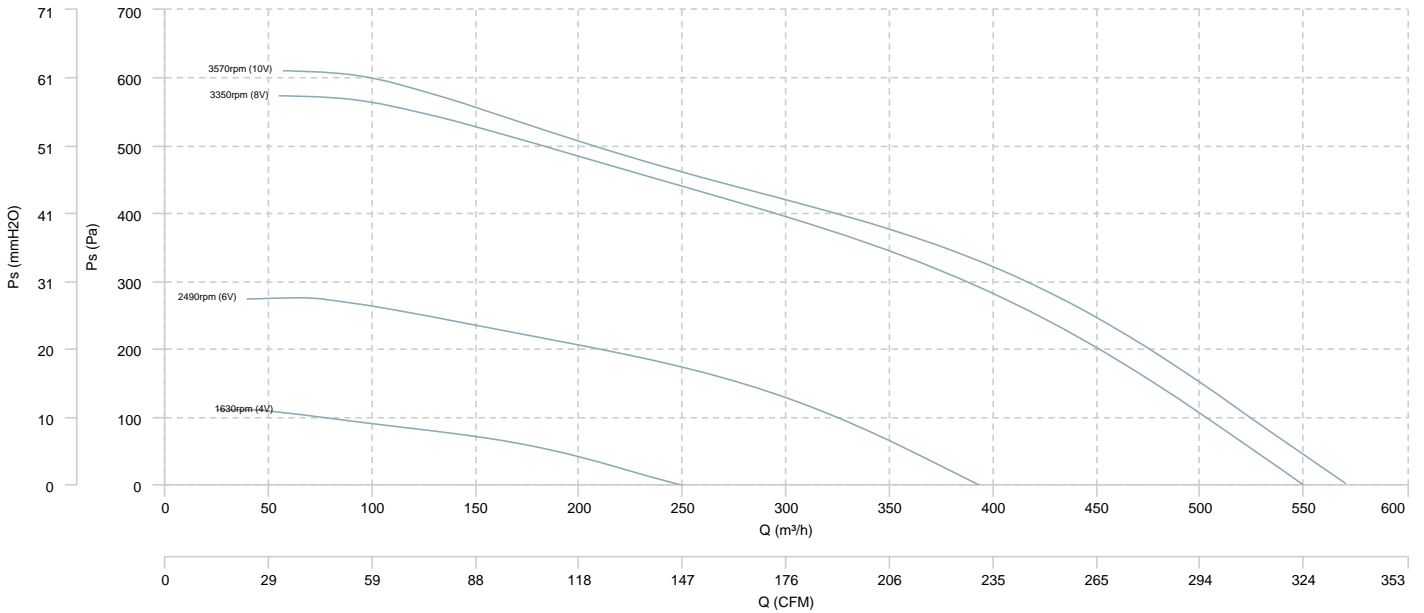

**AIR FLOW - MECHANICAL POWER**

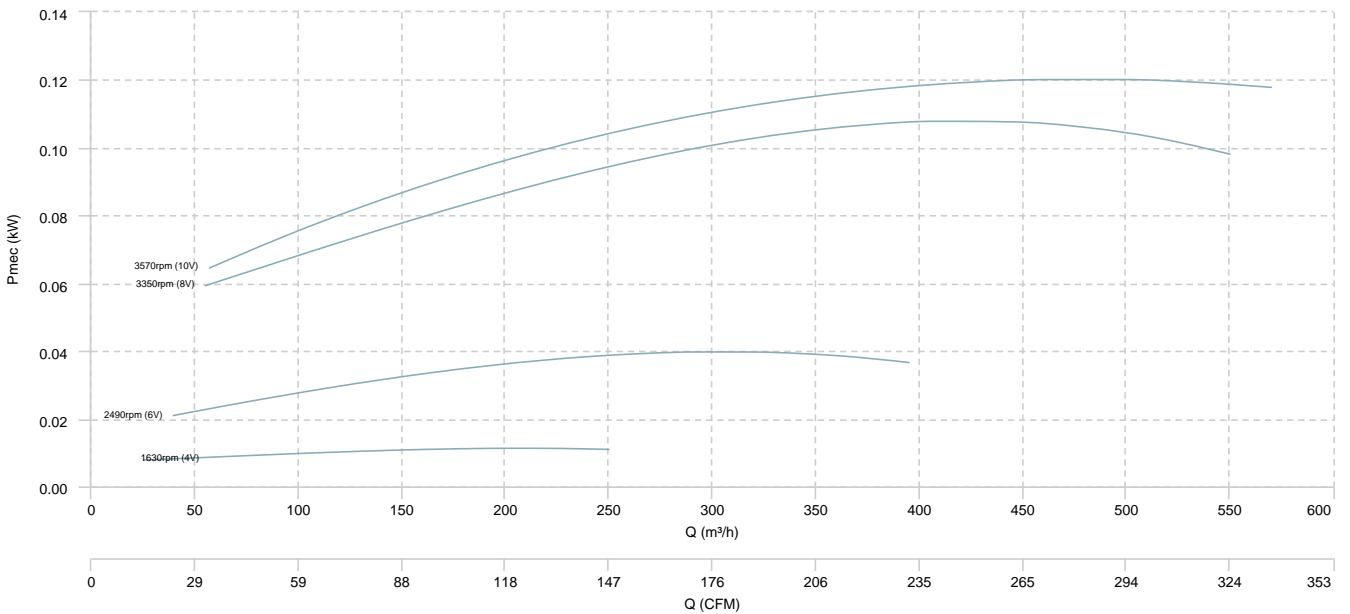

SBC-3 PLUS FILTER (ISO Coarse≥60%) 200 EEC

AIR FLOW - PRESSURE

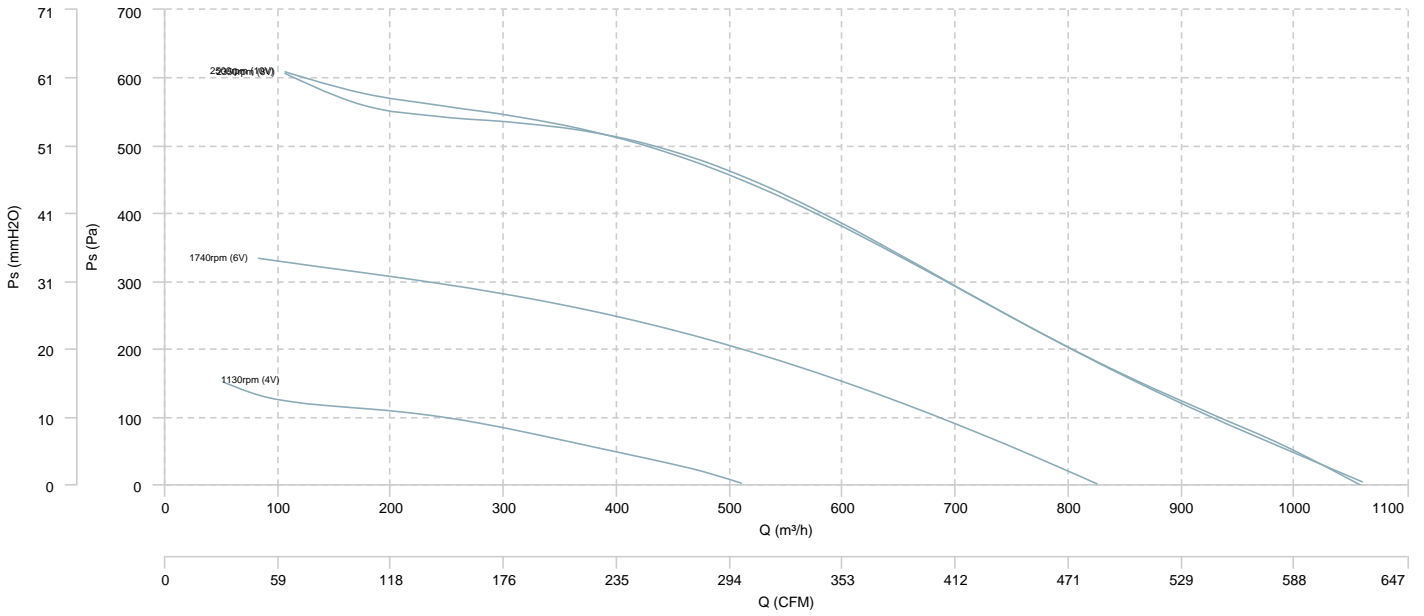

AIR FLOW - MECHANICAL POWER

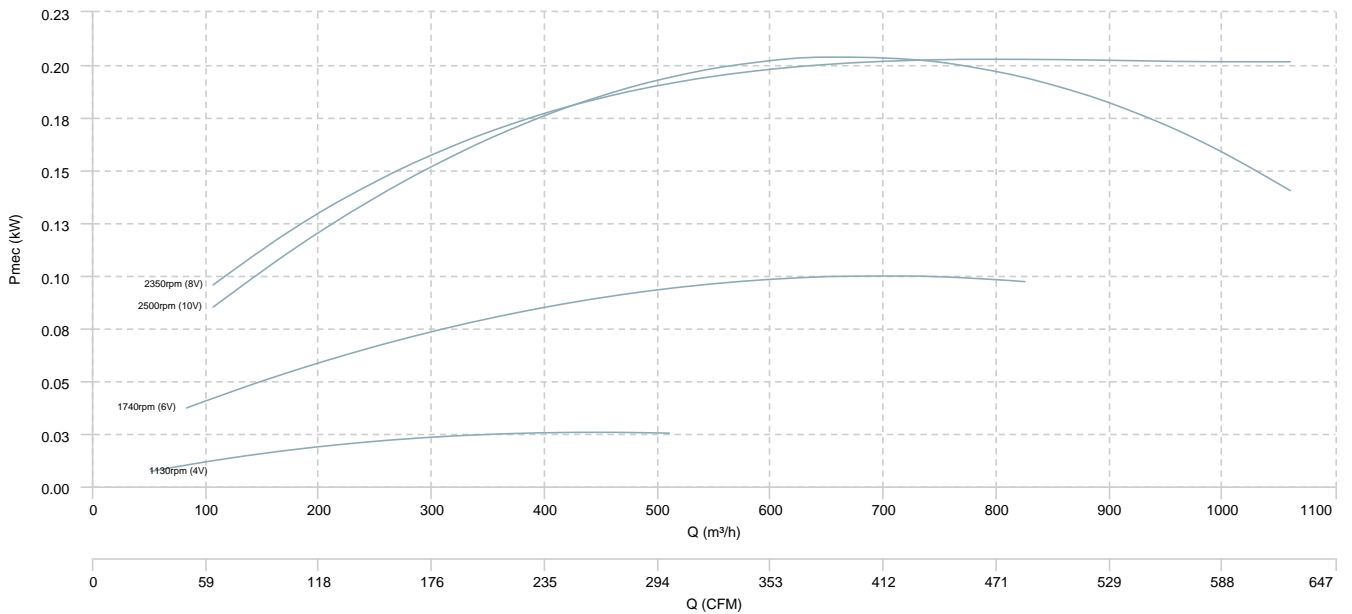

SBC-3 PLUS FILTER (ISO Coarse $\geq$ 60%) 250 EEC

**AIR FLOW - PRESSURE**

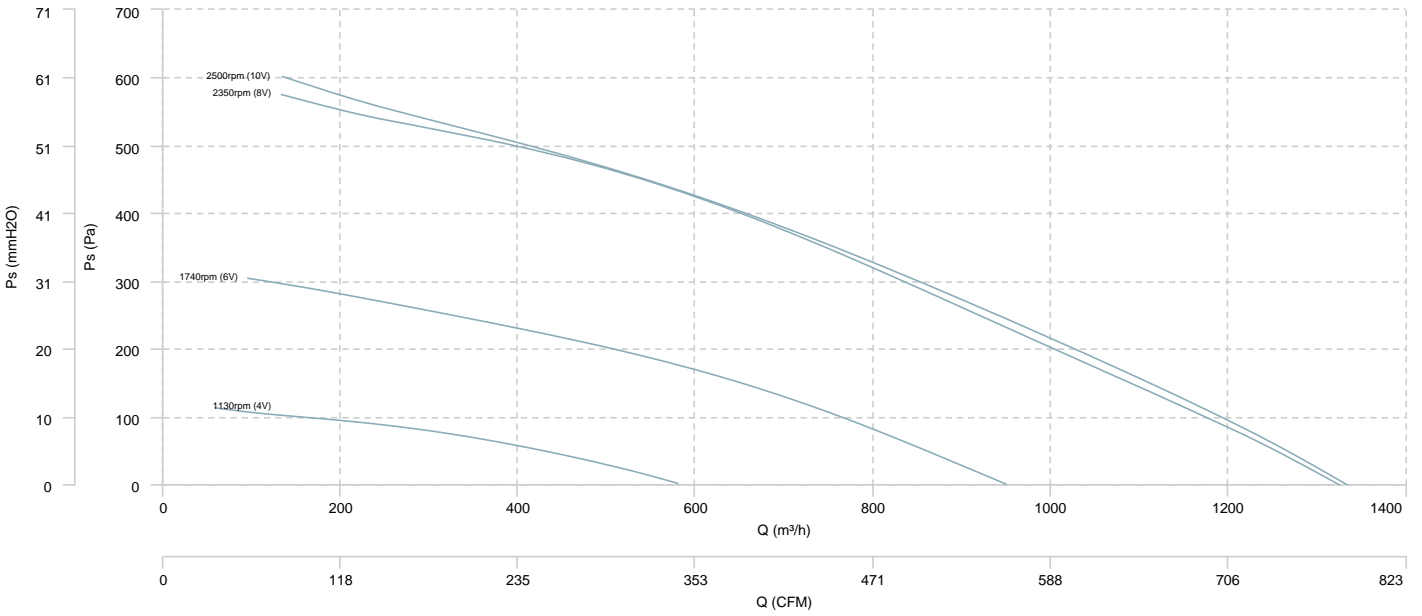

**AIR FLOW - MECHANICAL POWER**

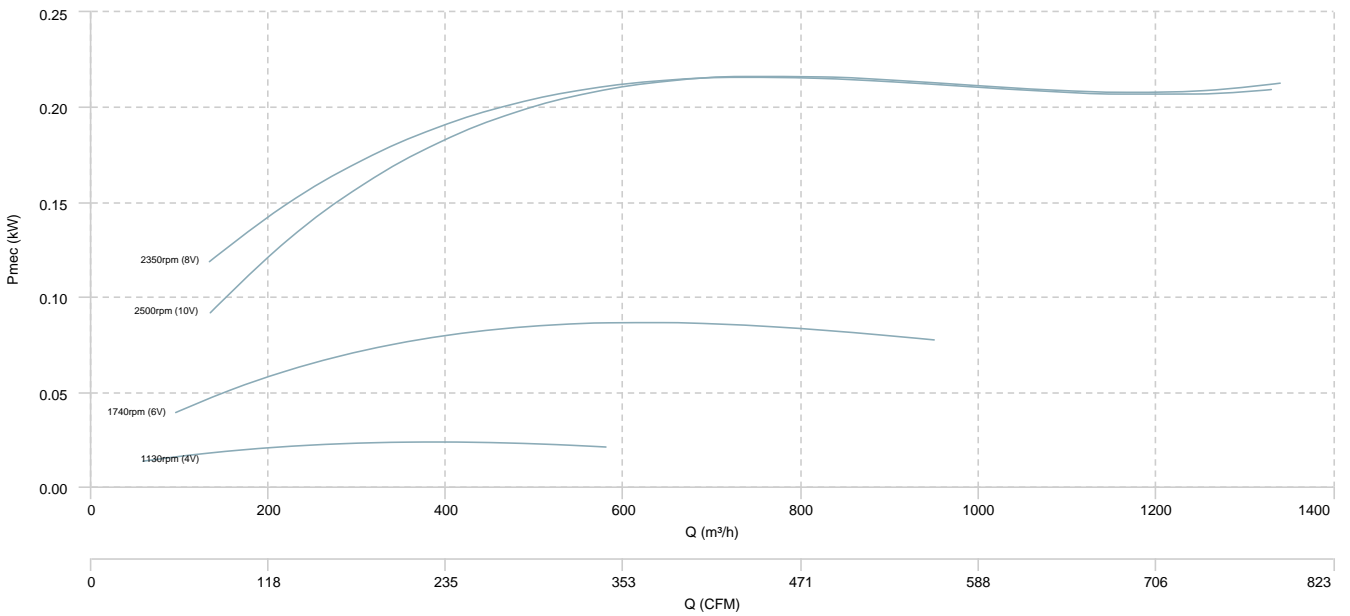

SBC-3 PLUS FILTER (ISO Coarse $\geq$ 60%) 315 EEC

**AIR FLOW - PRESSURE**

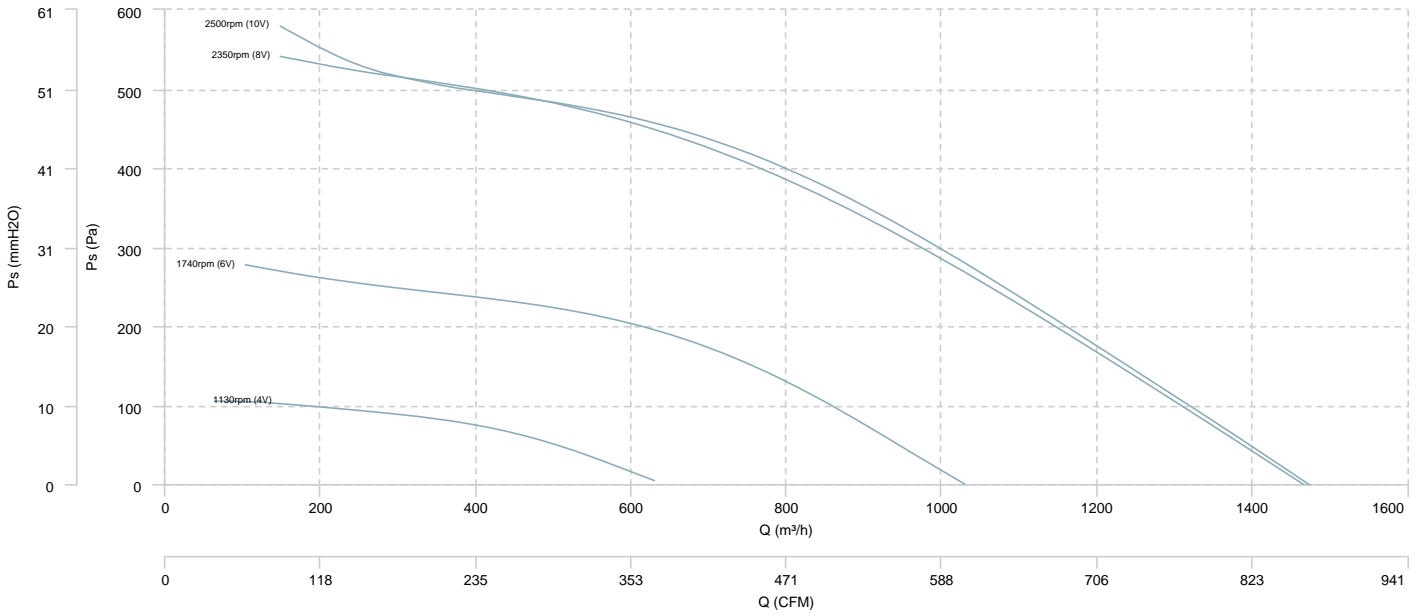

**AIR FLOW - MECHANICAL POWER**

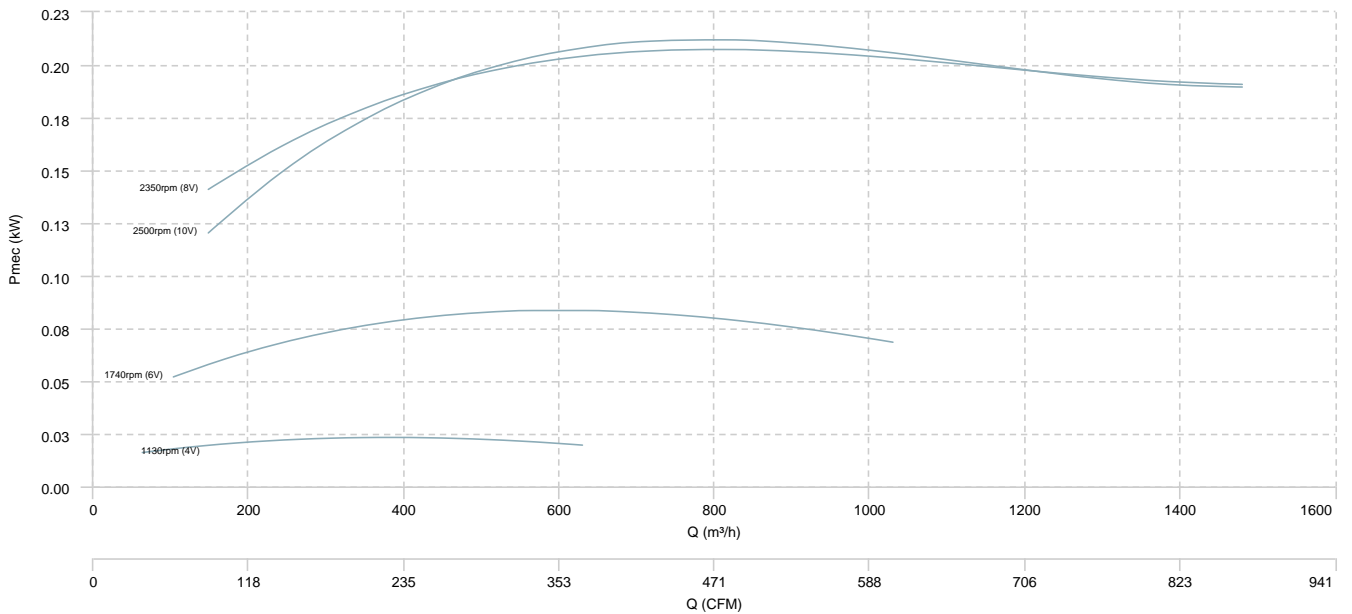

SBC-3 PLUS FILTER (ISO Coarse $\geq$ 60%) 355 EEC

**AIR FLOW - PRESSURE**

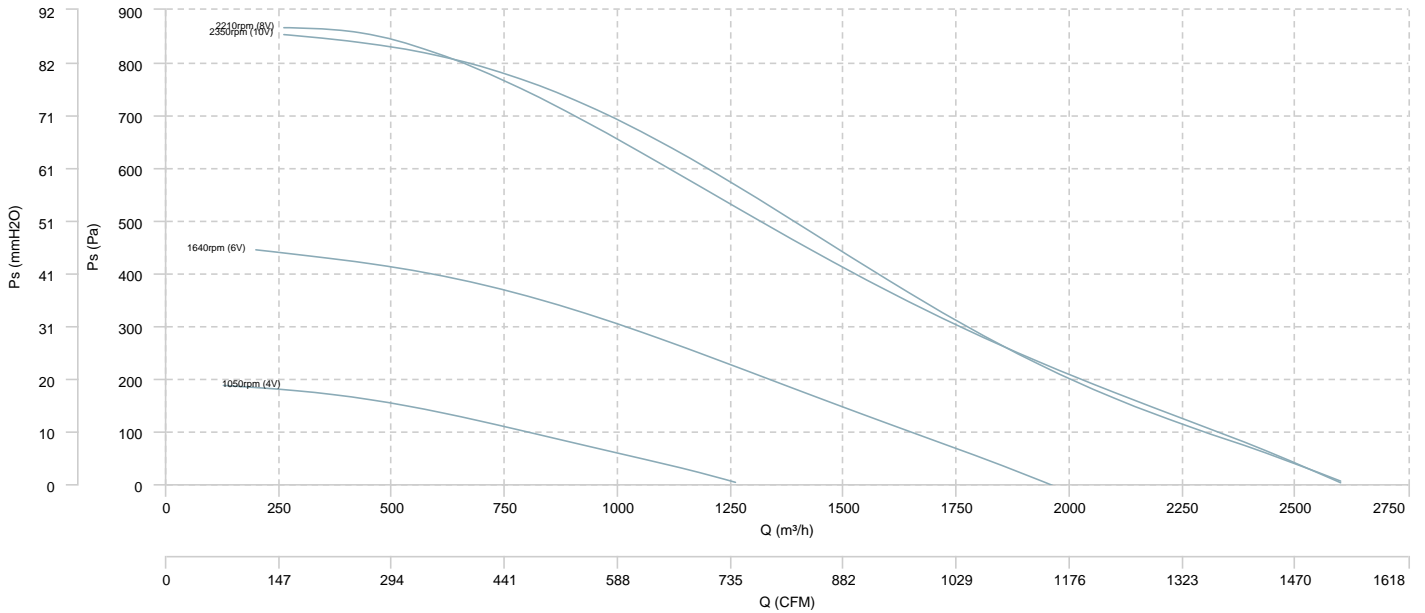

**AIR FLOW - MECHANICAL POWER**

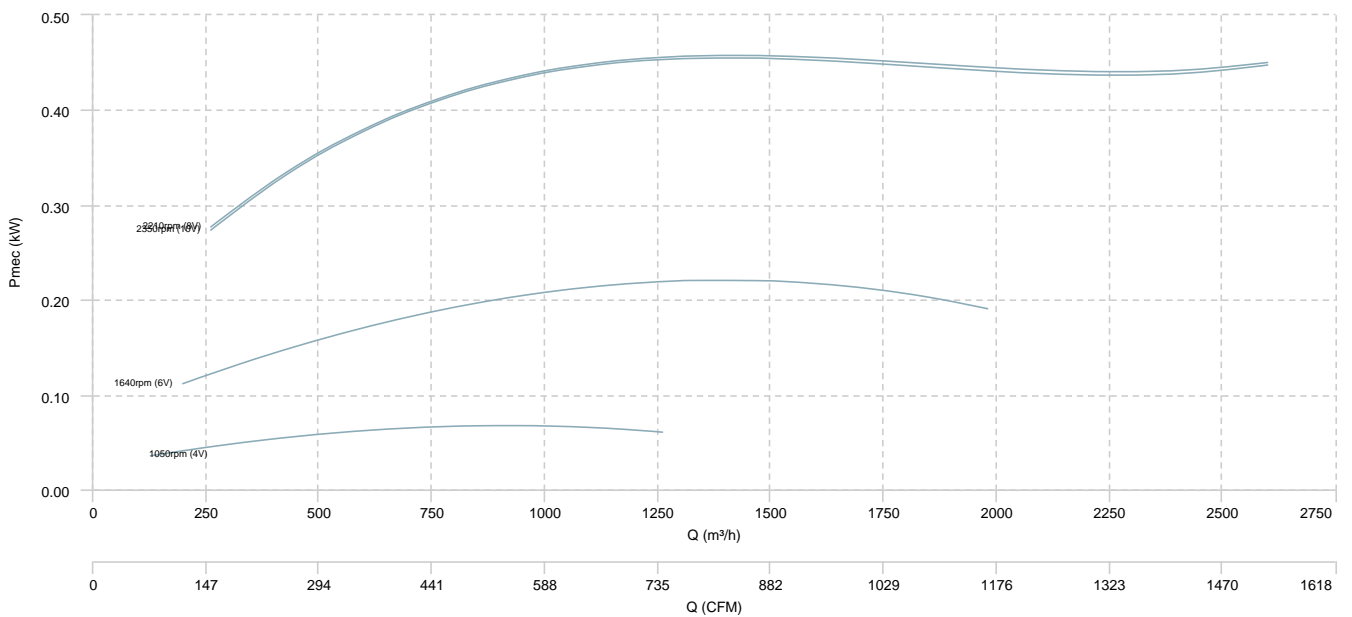

SBC-3 PLUS FILTER (ISO Coarse $\geq$ 60%) 400 EEC

AIR FLOW - PRESSURE

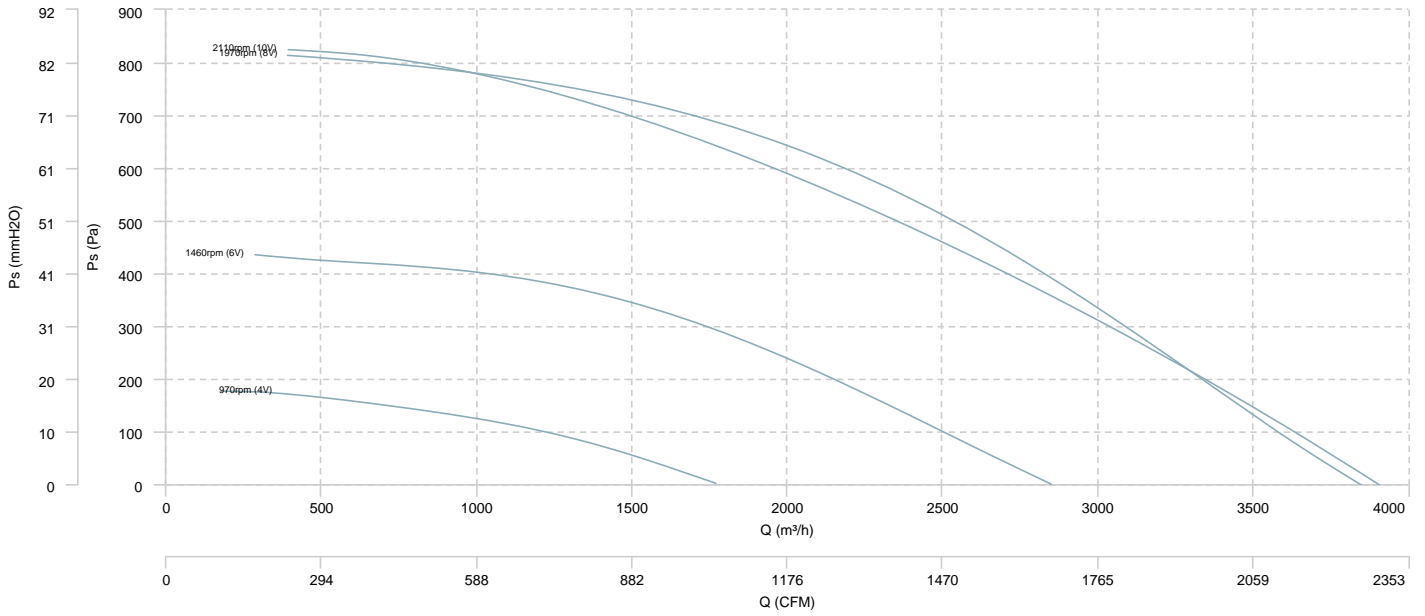

AIR FLOW - MECHANICAL POWER

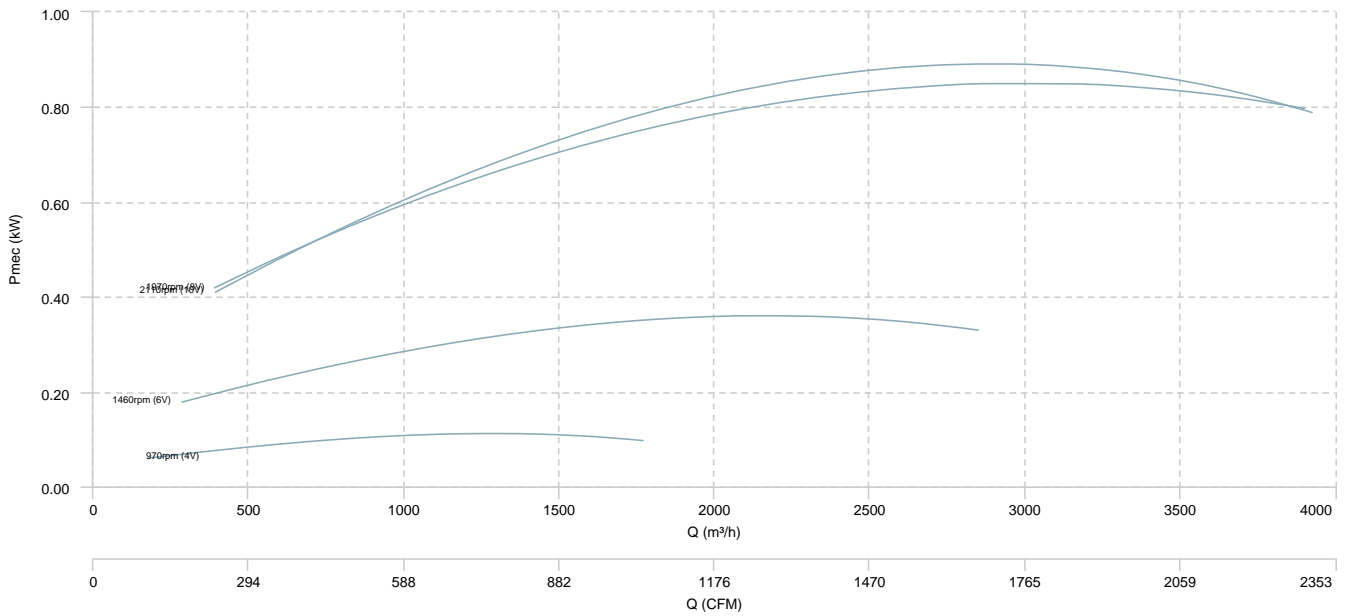



SBC-3 PLUS FILTER (ISO Coarse $\geq$ 60%) 450 EEC

**AIR FLOW - PRESSURE**

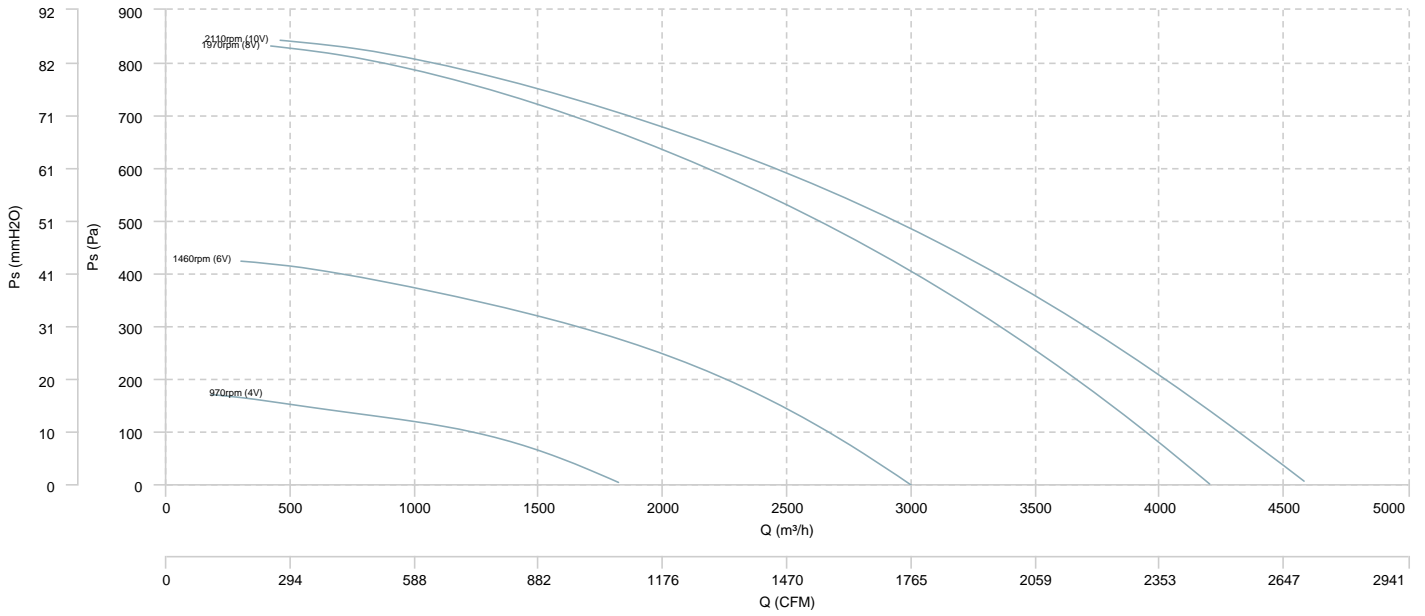

**AIR FLOW - MECHANICAL POWER**

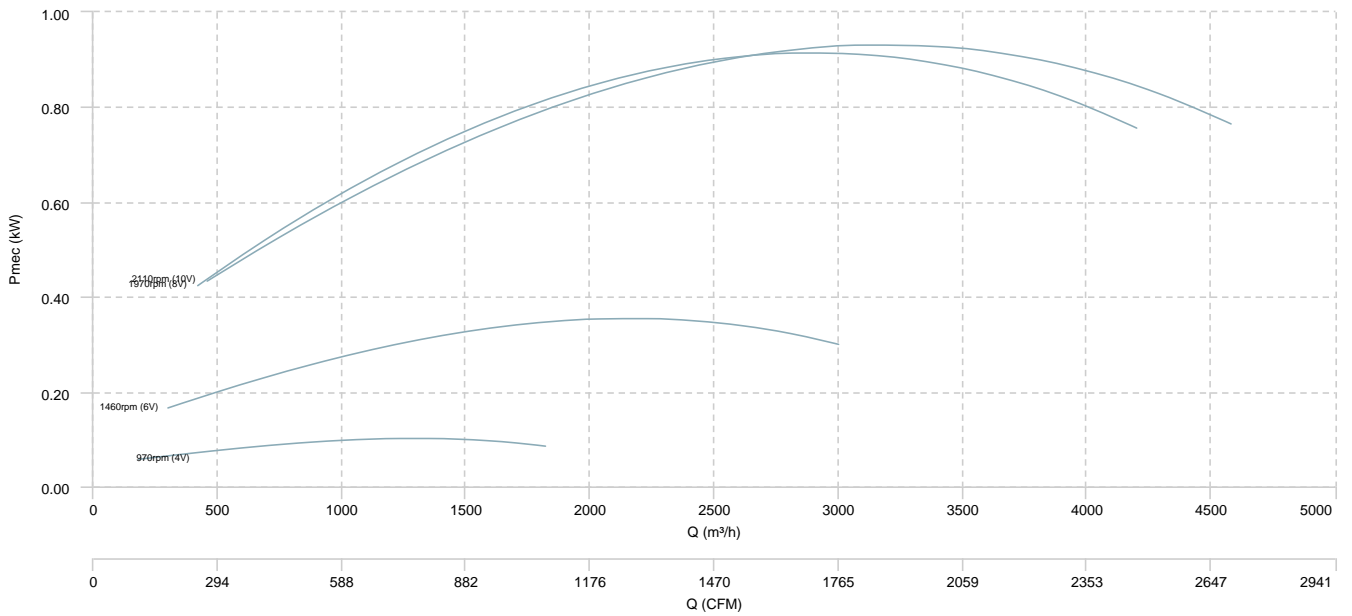

SBC-3 PLUS FILTER (ISO Coarse $\geq$ 60%) 500 EEC

AIR FLOW - PRESSURE

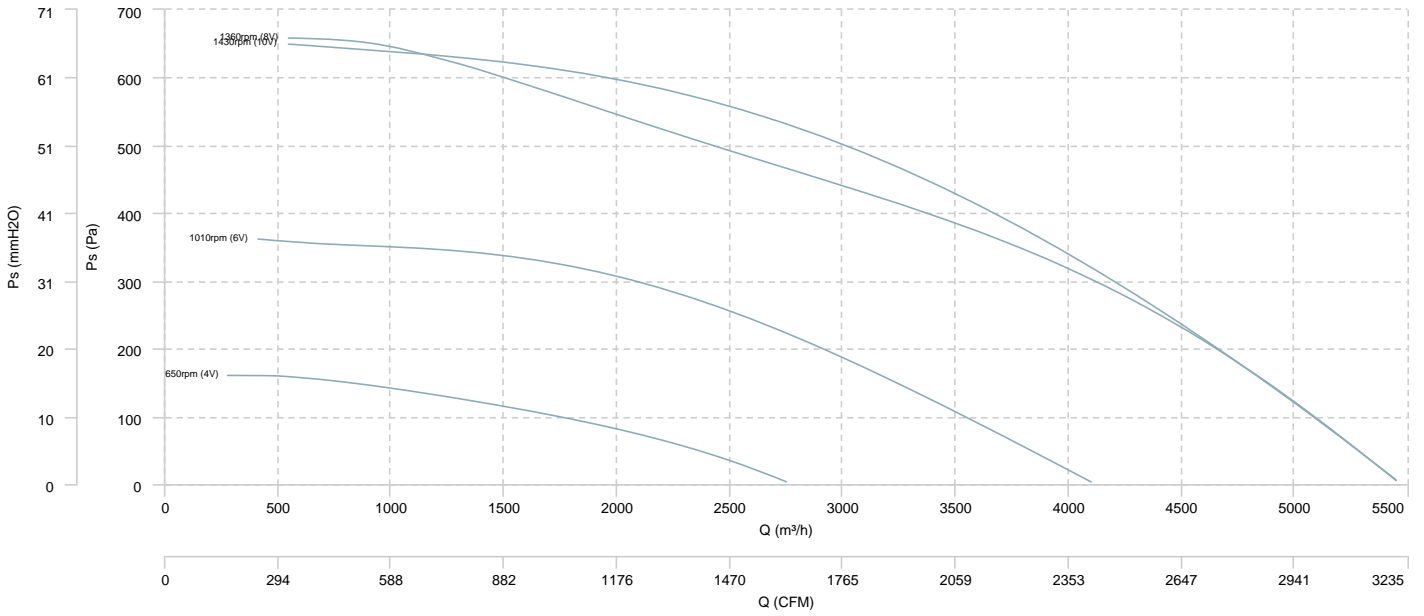

AIR FLOW - MECHANICAL POWER

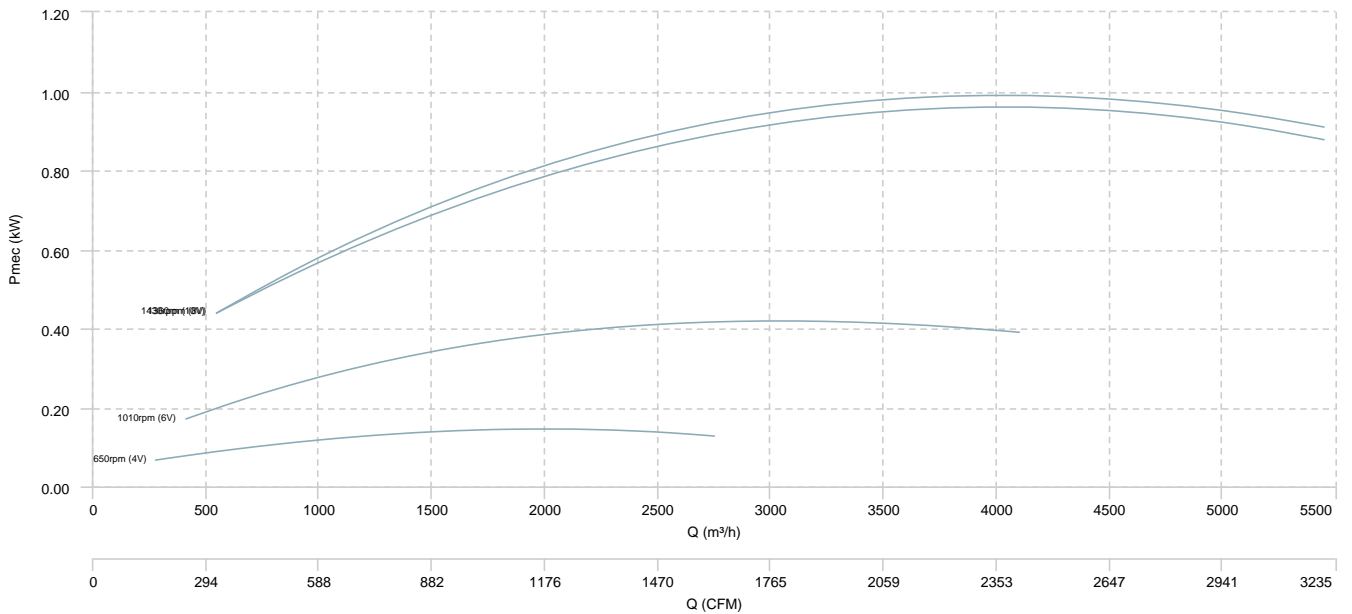

SBC-3 PLUS FILTER (ISO Coarse $\geq$ 60%) 560 EEC

**AIR FLOW - PRESSURE**

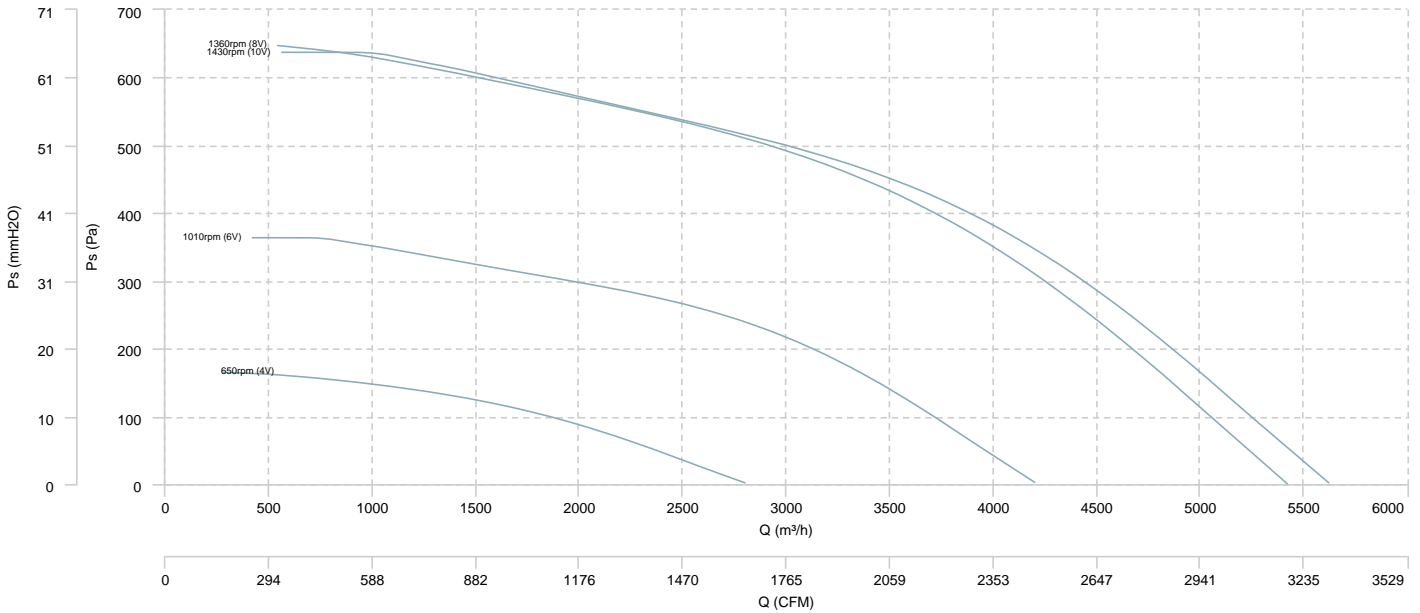

**AIR FLOW - MECHANICAL POWER**

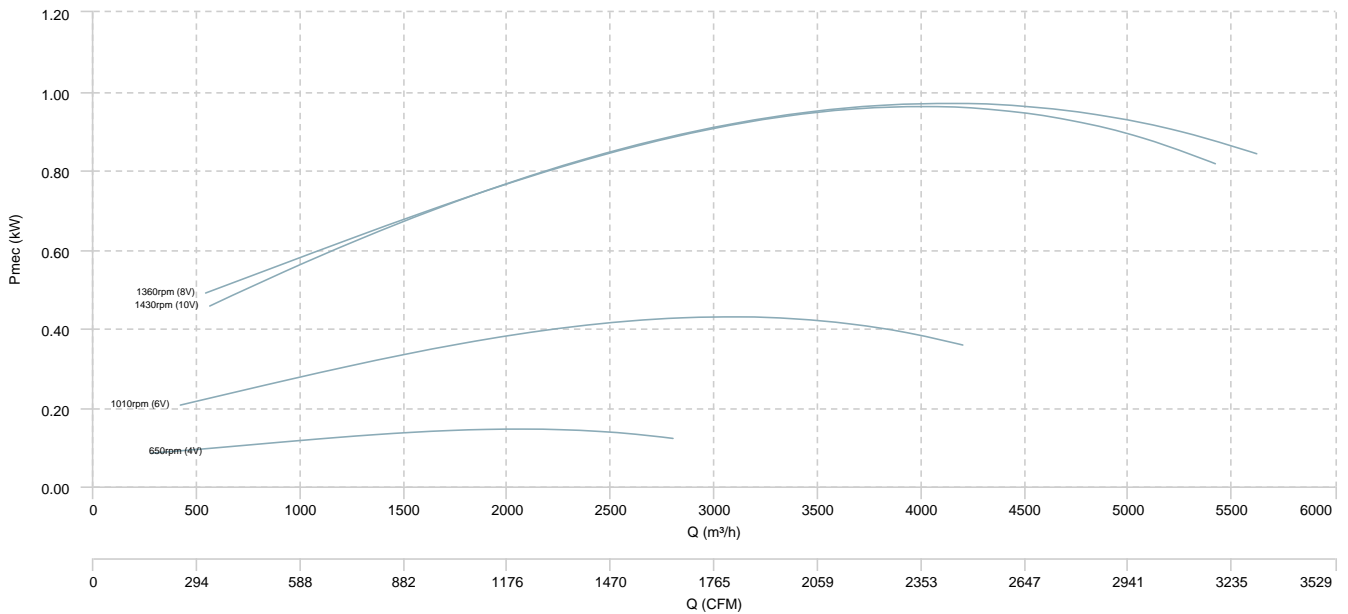

SBC-3 PLUS FILTER (ISO  
Coarse $\geq$ 60%+ePM1 $\geq$ 50%  
) 125 EEC

**AIR FLOW - PRESSURE**

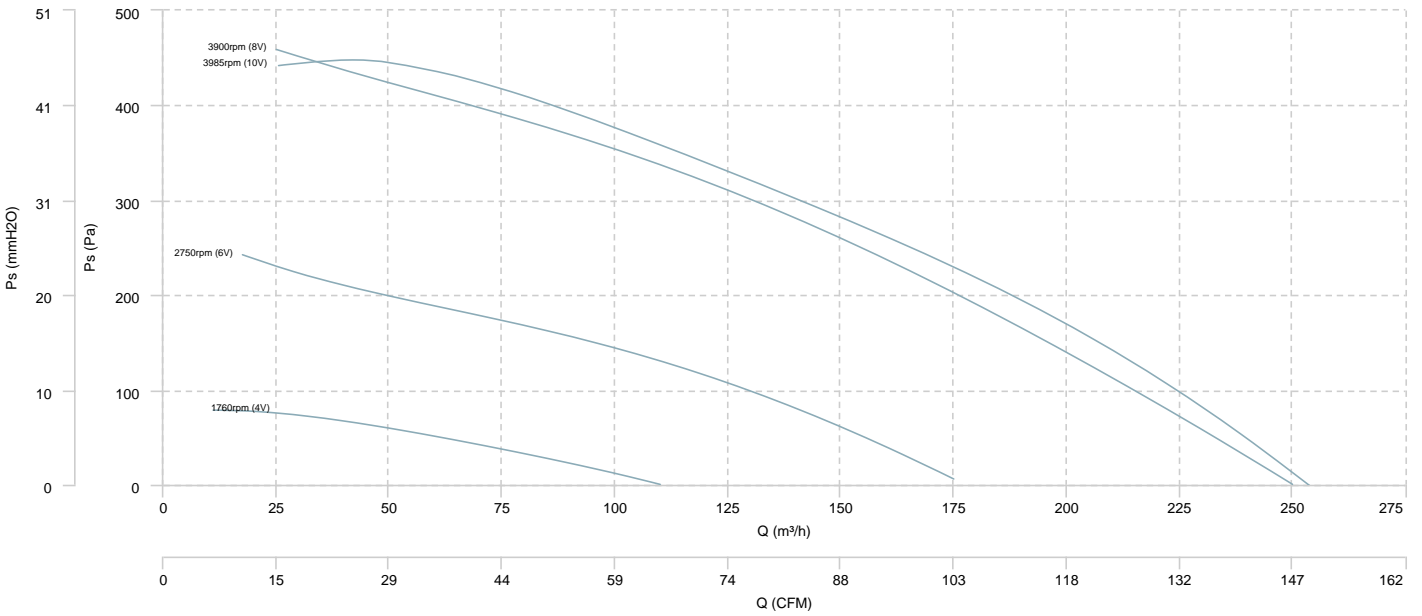

**AIR FLOW - MECHANICAL POWER**

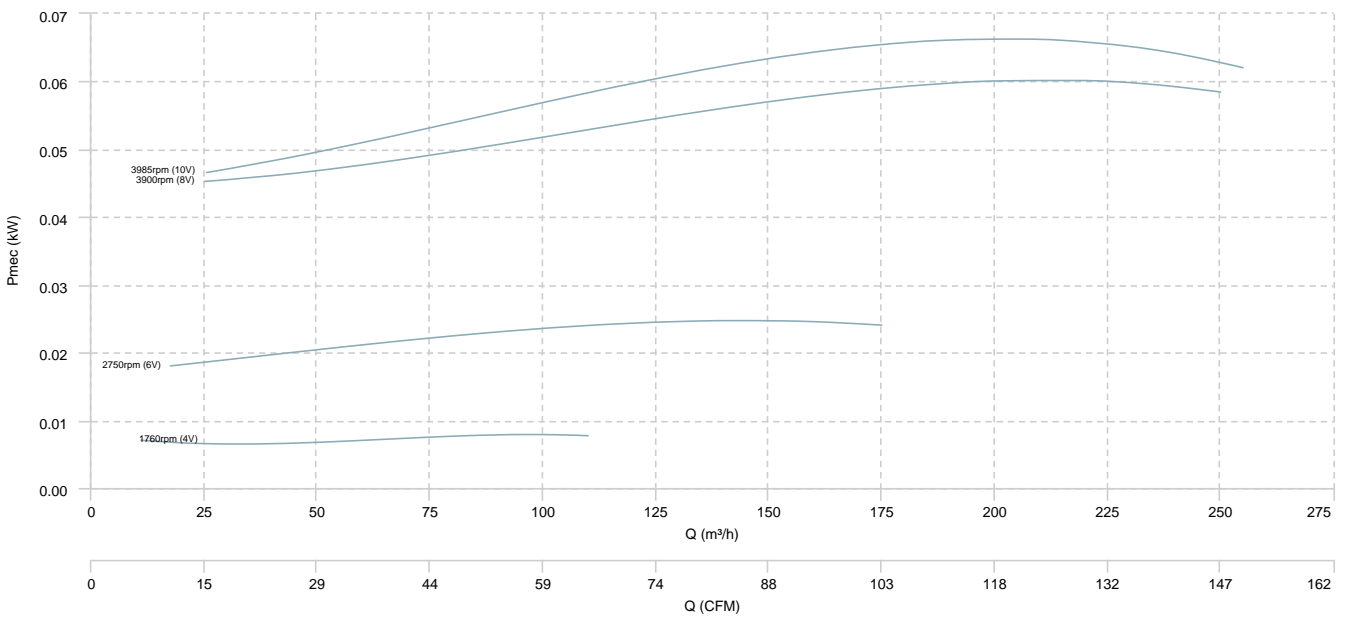

SBC-3 PLUS FILTER (ISO  
Coarse $\geq$ 60%+ePM1 $\geq$ 50%  
) 150 EEC

**AIR FLOW - PRESSURE**

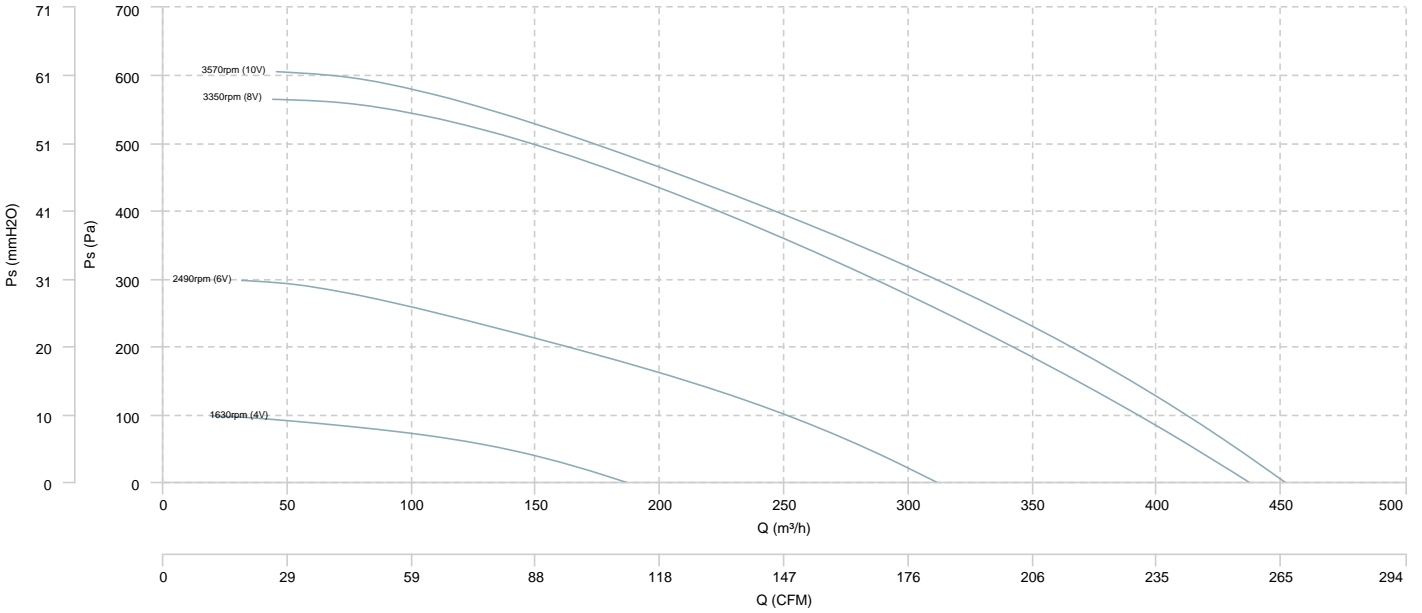

**AIR FLOW - MECHANICAL POWER**

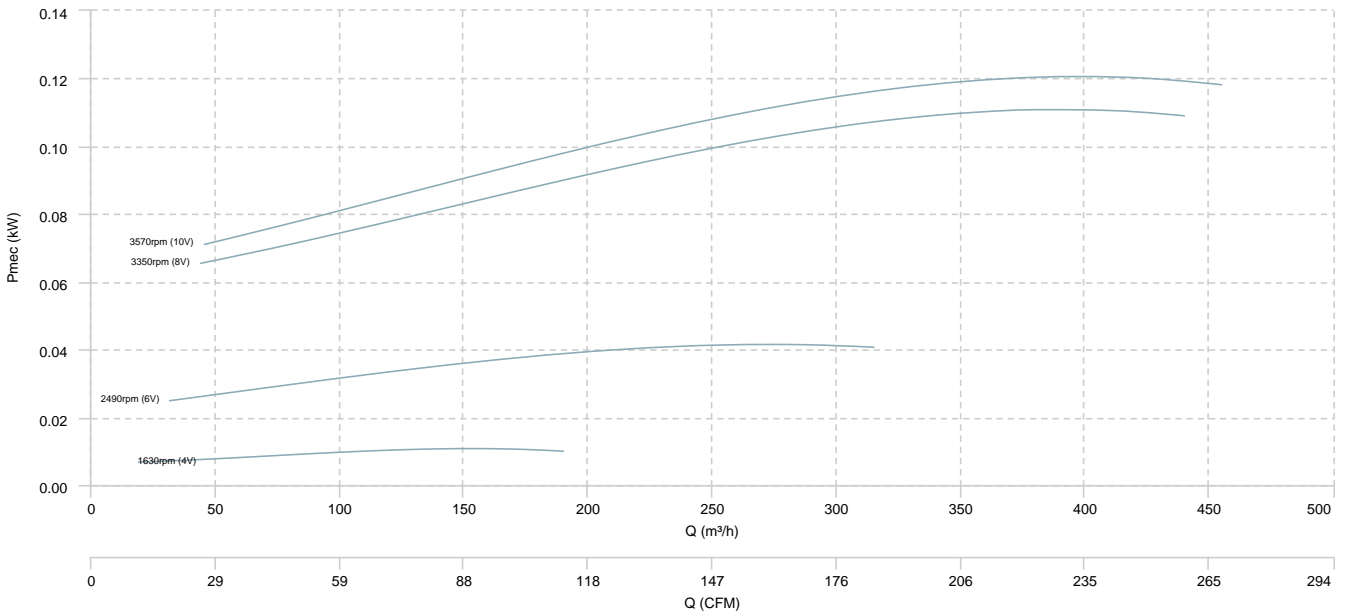

SBC-3 PLUS FILTER (ISO  
Coarse $\geq$ 60%+ePM1 $\geq$ 50%  
) 160 EEC

**AIR FLOW - PRESSURE**

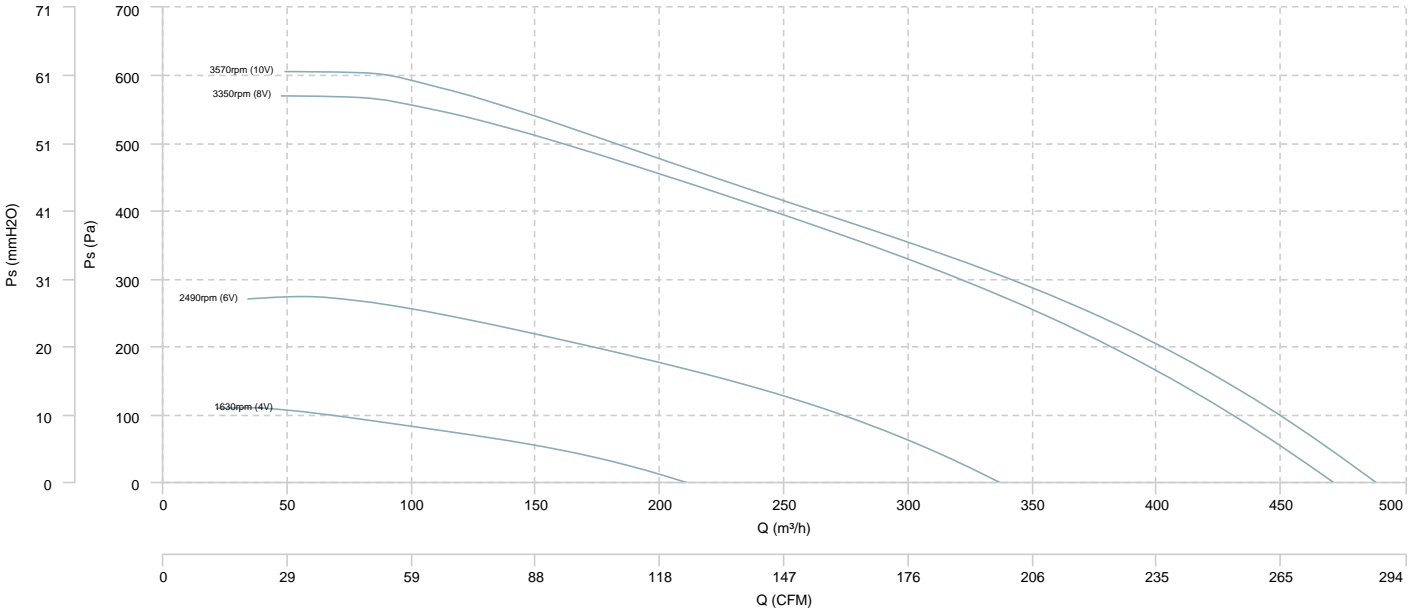

**AIR FLOW - MECHANICAL POWER**

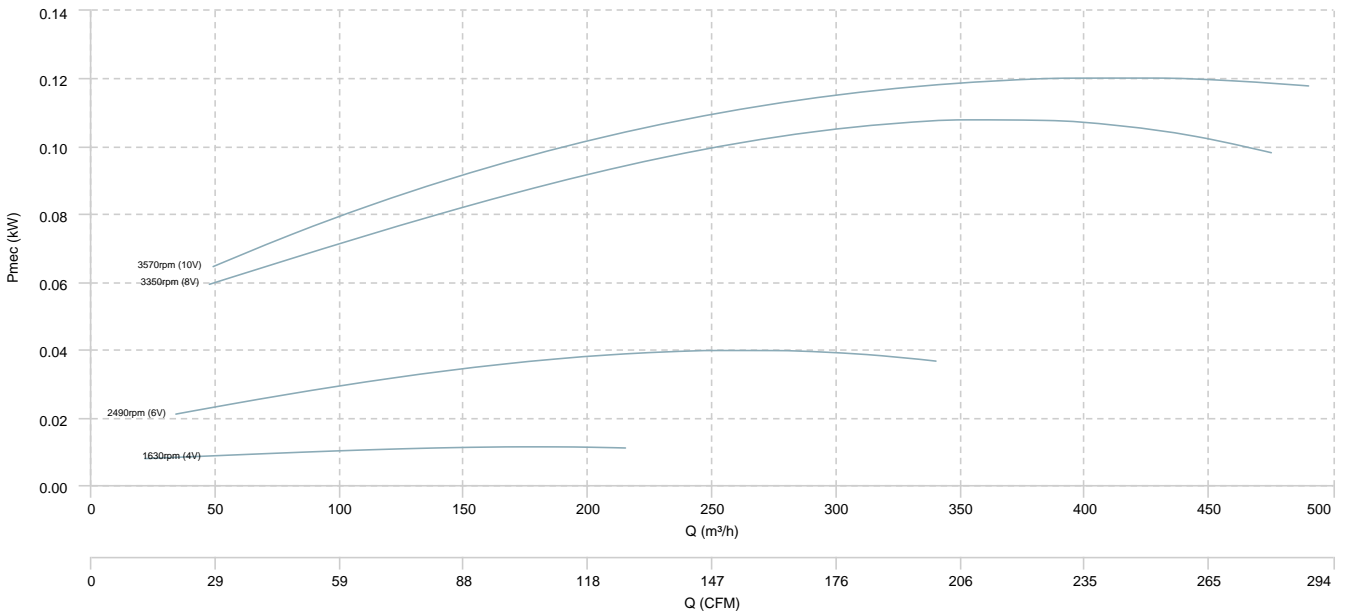

SBC-3 PLUS FILTER (ISO  
Coarse $\geq$ 60%+ePM1 $\geq$ 50%  
) 200 EEC

**AIR FLOW - PRESSURE**

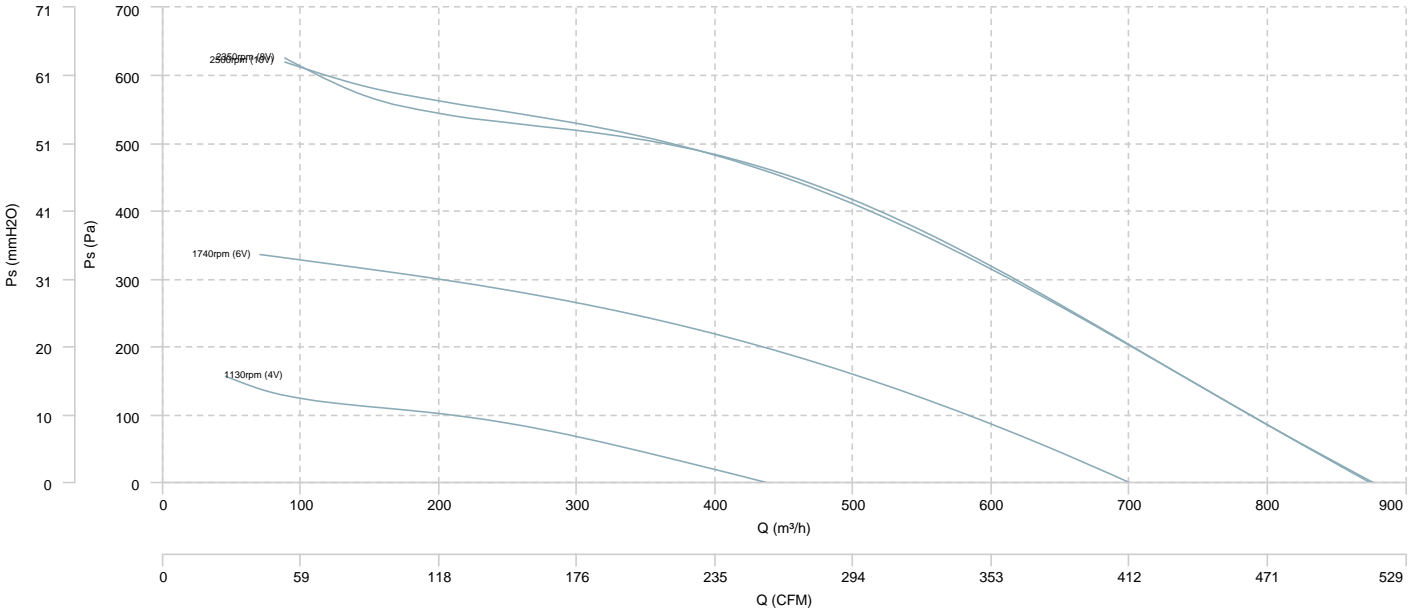

**AIR FLOW - MECHANICAL POWER**

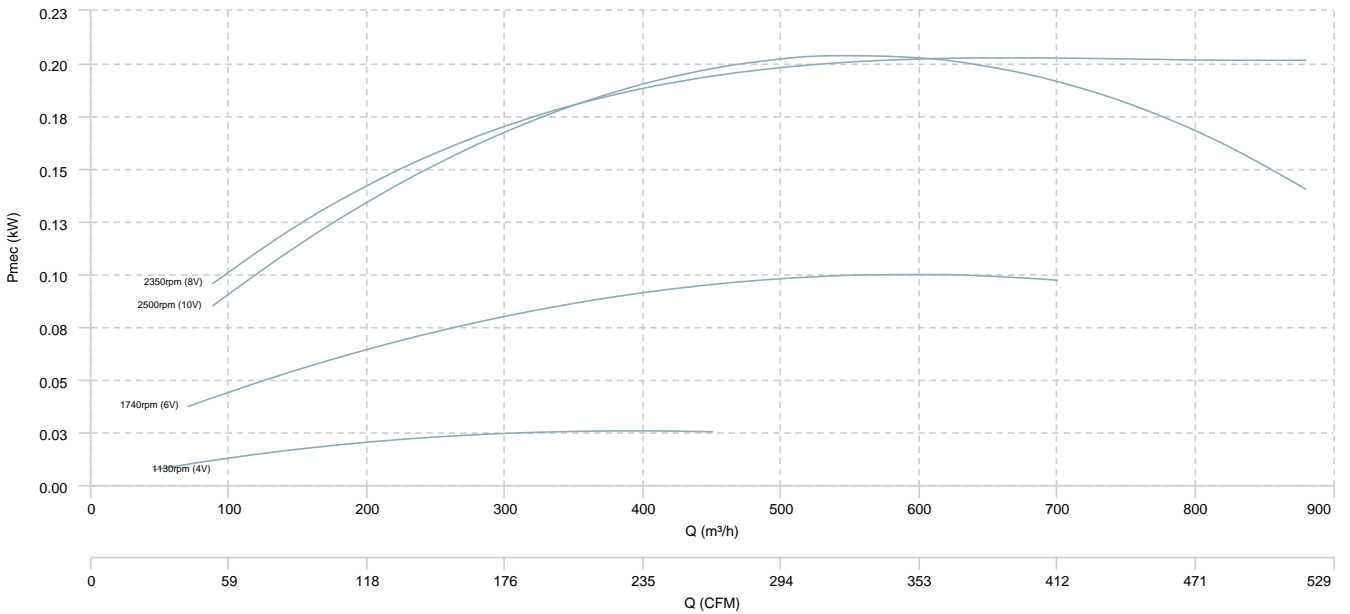

SBC-3 PLUS FILTER (ISO  
Coarse $\geq$ 60%+ePM1 $\geq$ 50%  
) 250 EEC

**AIR FLOW - PRESSURE**

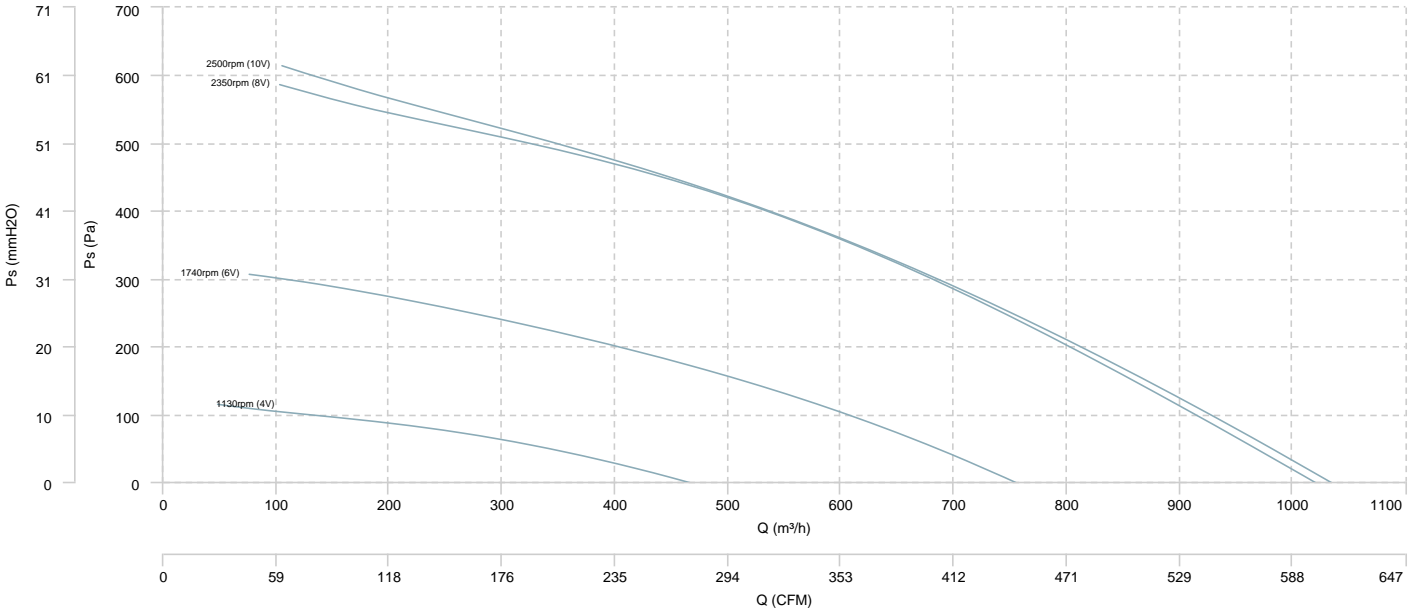

**AIR FLOW - MECHANICAL POWER**

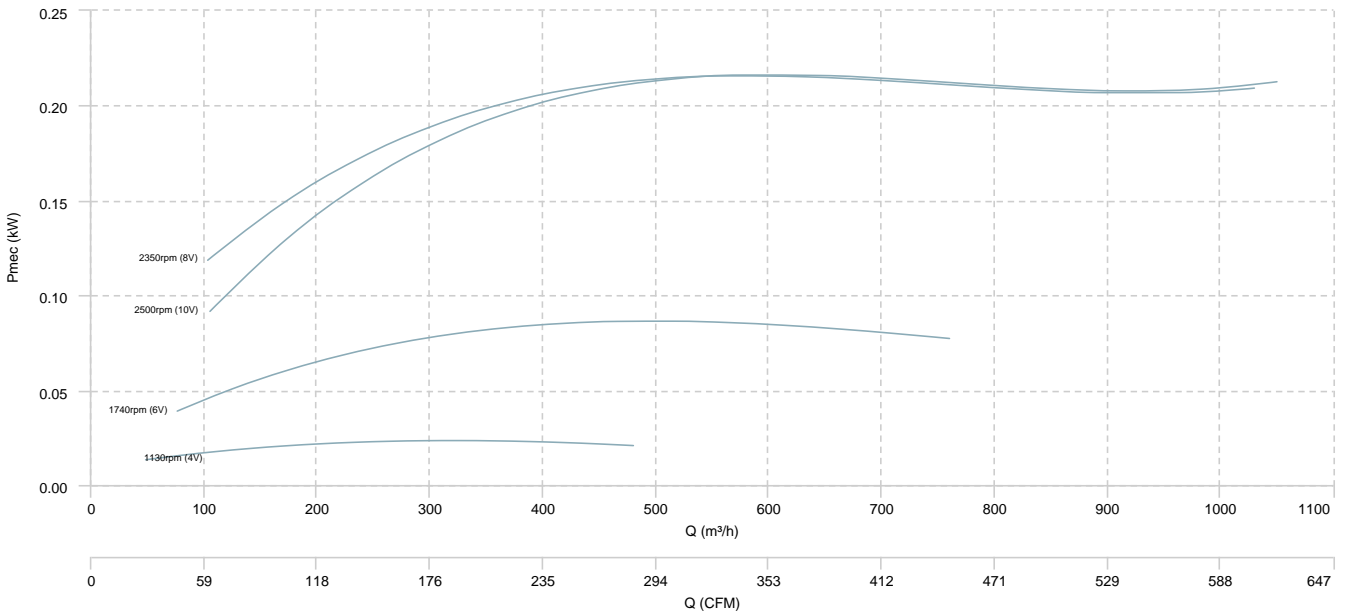



SBC-3 PLUS FILTER (ISO  
Coarse $\geq$ 60%+ePM1 $\geq$ 50%  
) 315 EEC

## AIR FLOW - PRESSURE

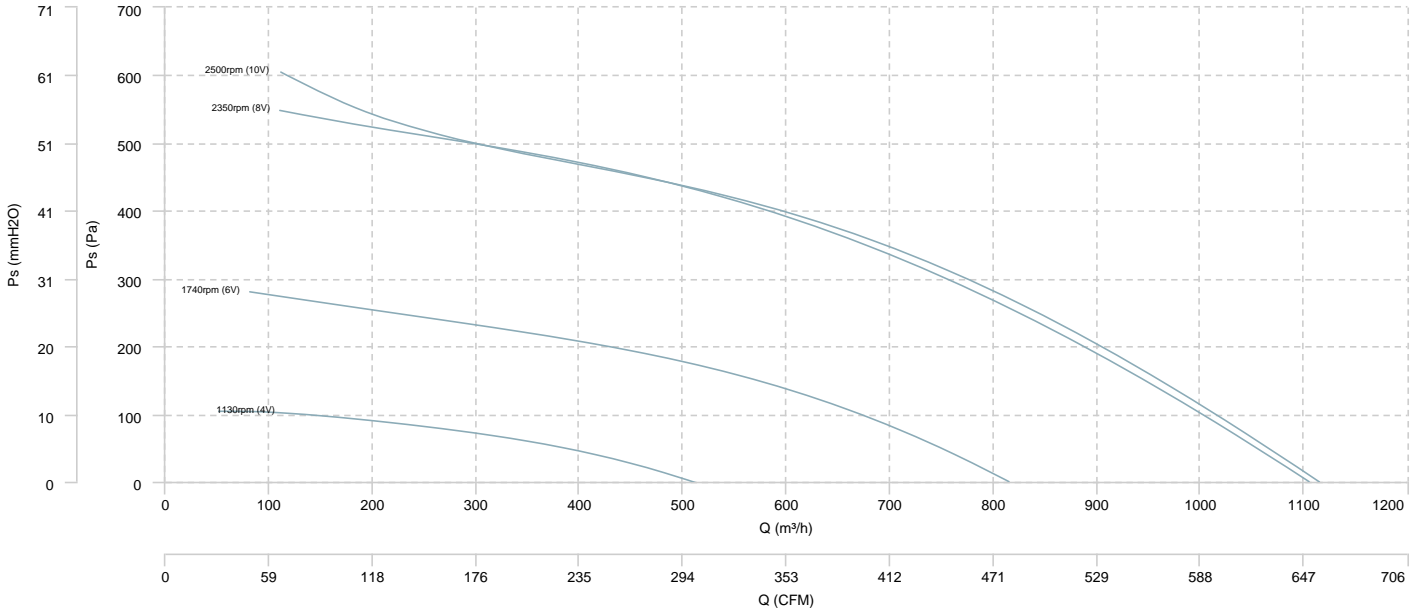

## AIR FLOW - MECHANICAL POWER

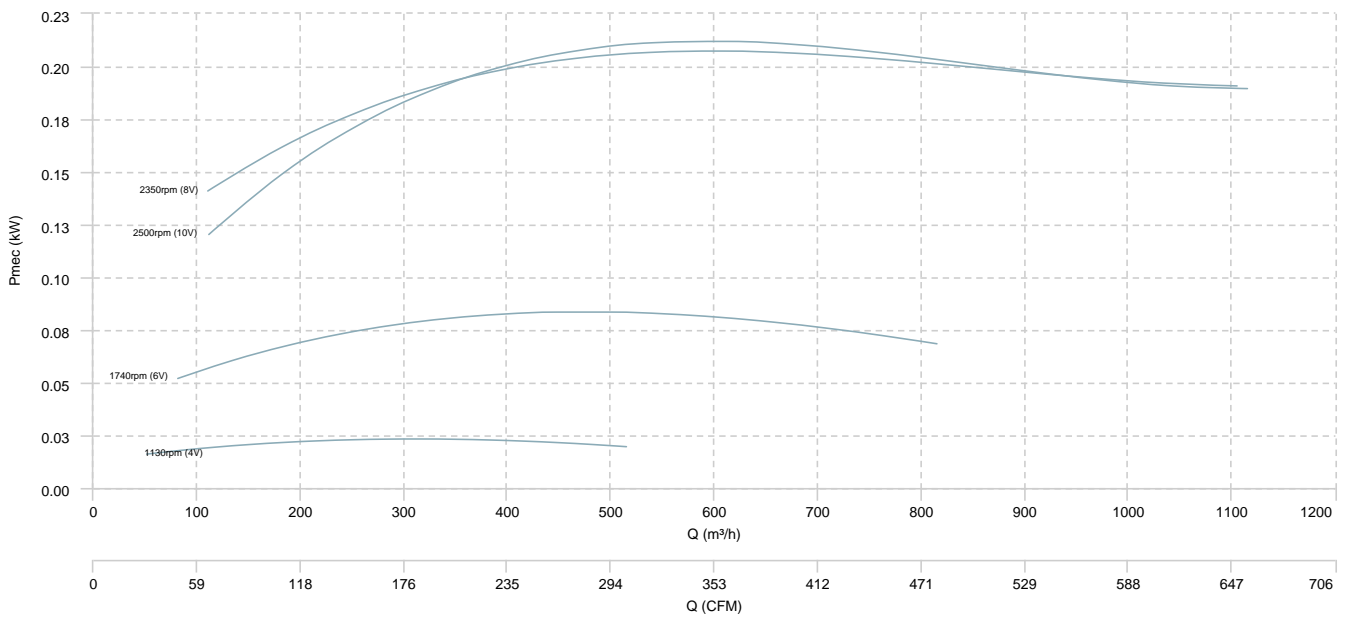

SBC-3 PLUS FILTER (ISO  
Coarse $\geq$ 60%+ePM1 $\geq$ 50%  
) 355 EEC

## AIR FLOW - PRESSURE

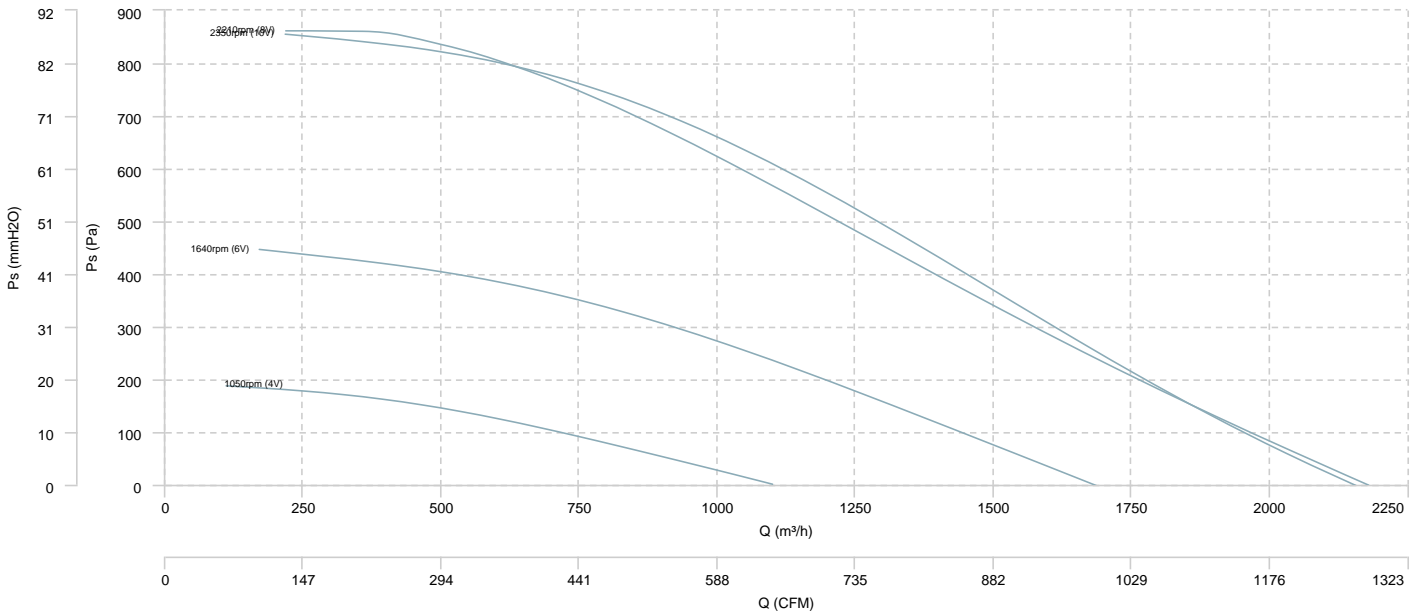

## AIR FLOW - MECHANICAL POWER

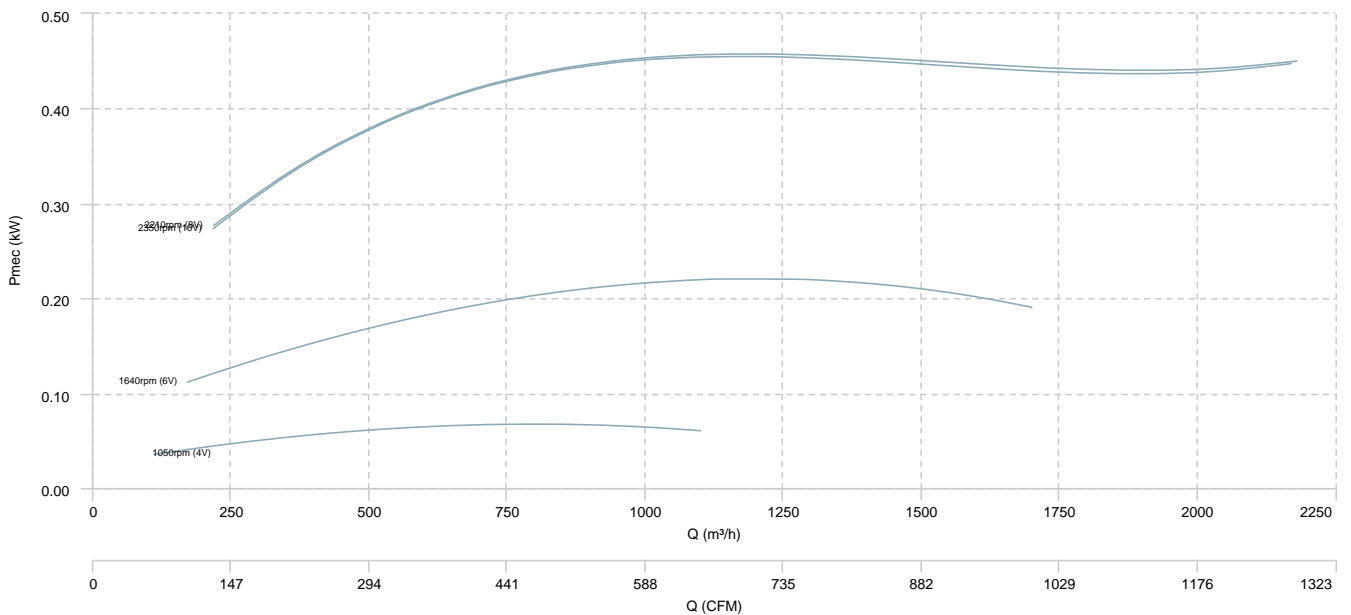

SBC-3 PLUS FILTER (ISO  
Coarse $\geq$ 60%+ePM1 $\geq$ 50%  
) 400 EEC

**AIR FLOW - PRESSURE**

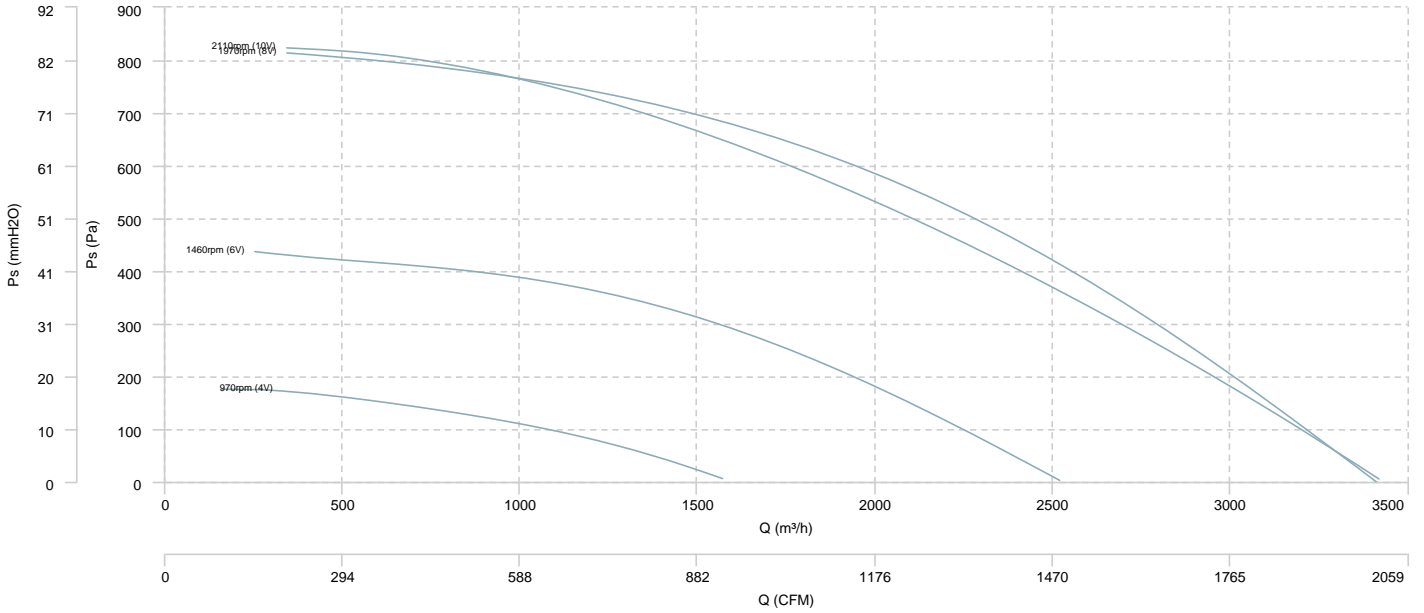

**AIR FLOW - MECHANICAL POWER**

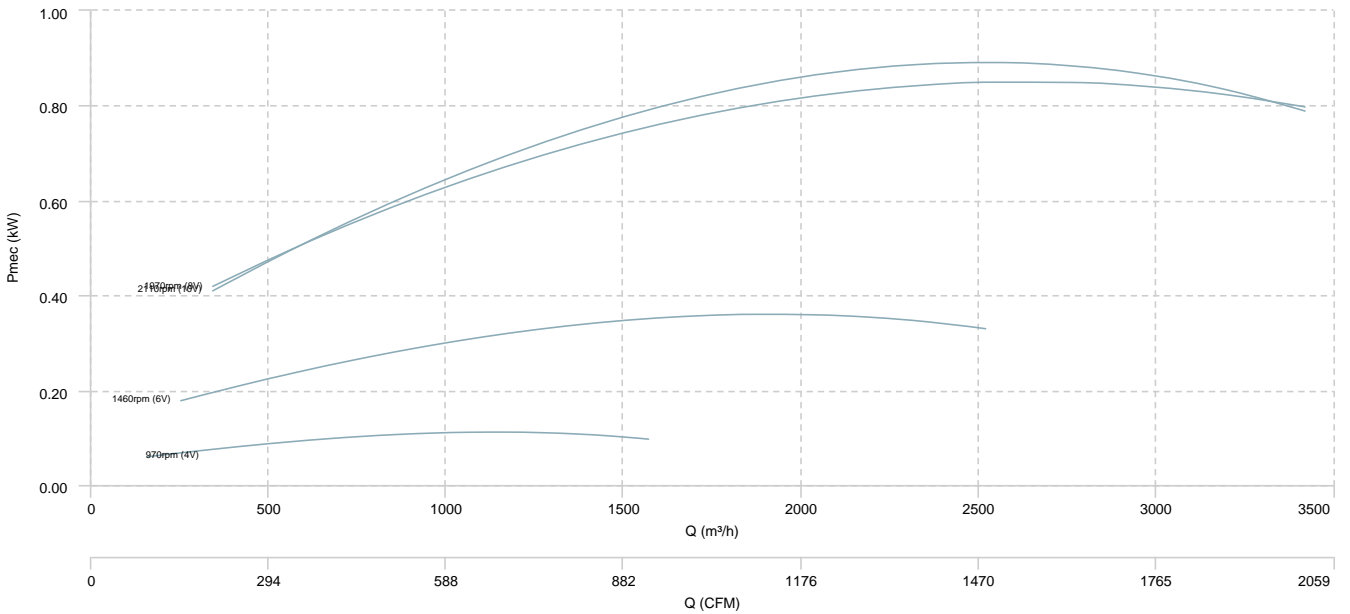

SBC-3 PLUS FILTER (ISO  
Coarse $\geq$ 60%+ePM1 $\geq$ 50%  
) 450 EEC

## AIR FLOW - PRESSURE

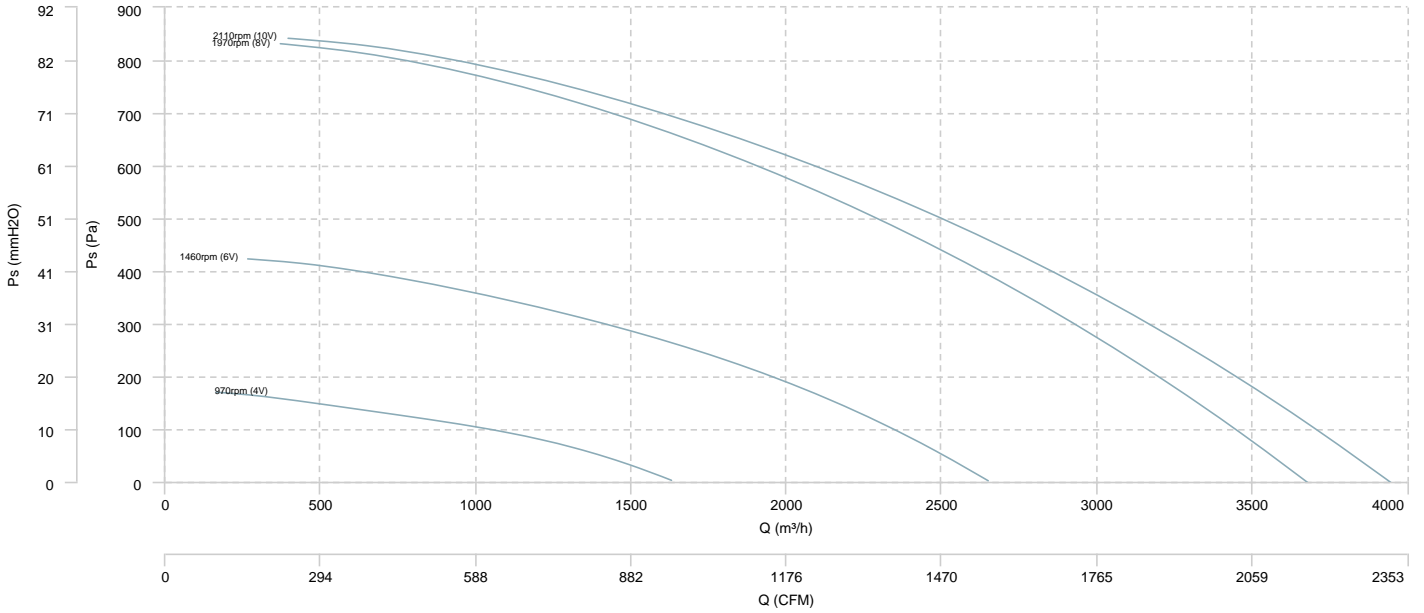

## AIR FLOW - MECHANICAL POWER

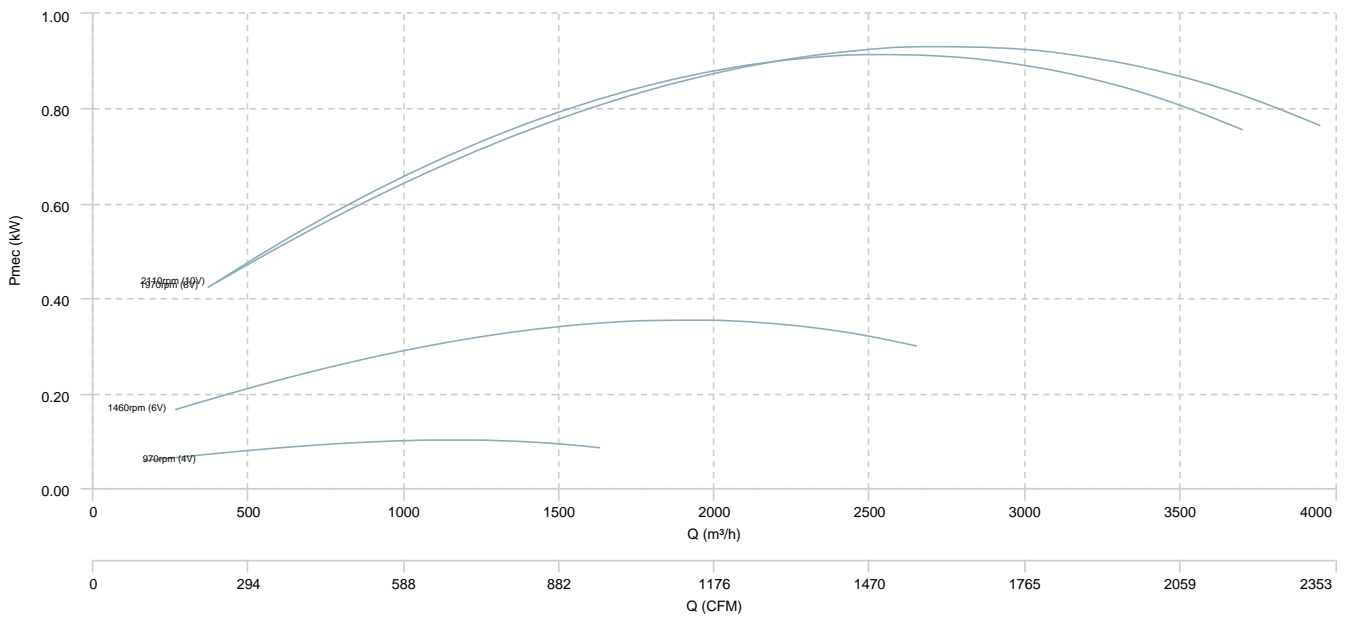

SBC-3 PLUS FILTER (ISO  
Coarse $\geq$ 60%+ePM1 $\geq$ 50%  
) 500 EEC

## AIR FLOW - PRESSURE

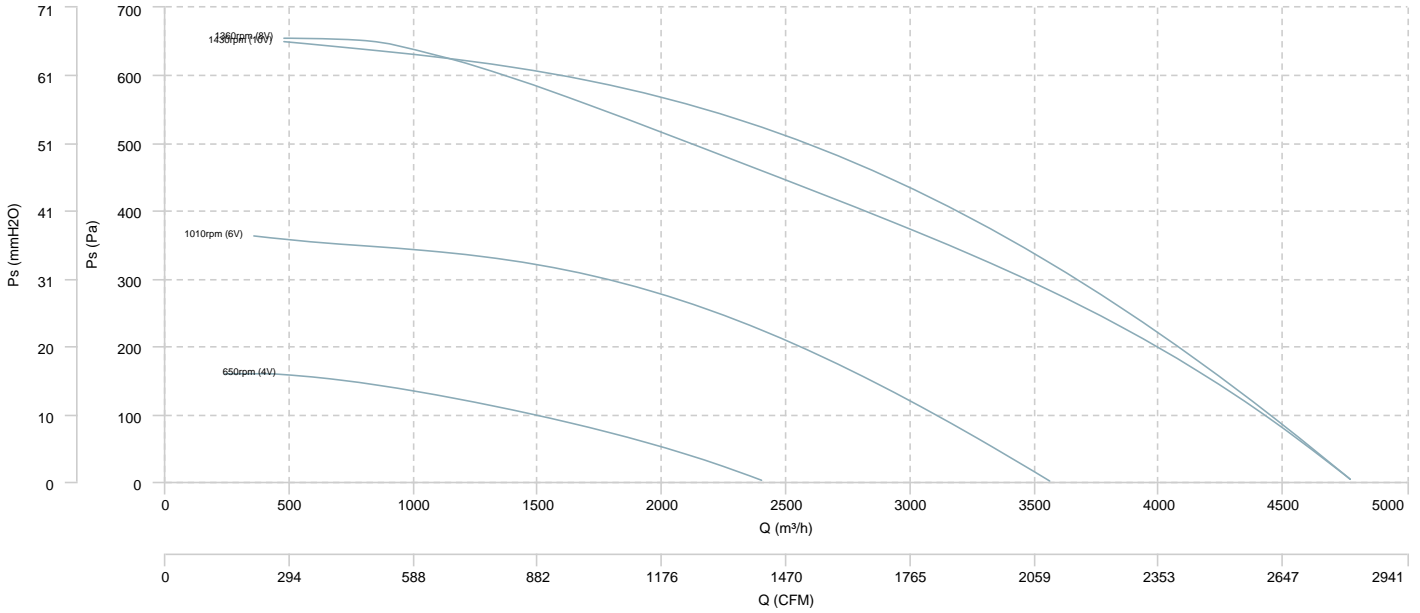

## AIR FLOW - MECHANICAL POWER

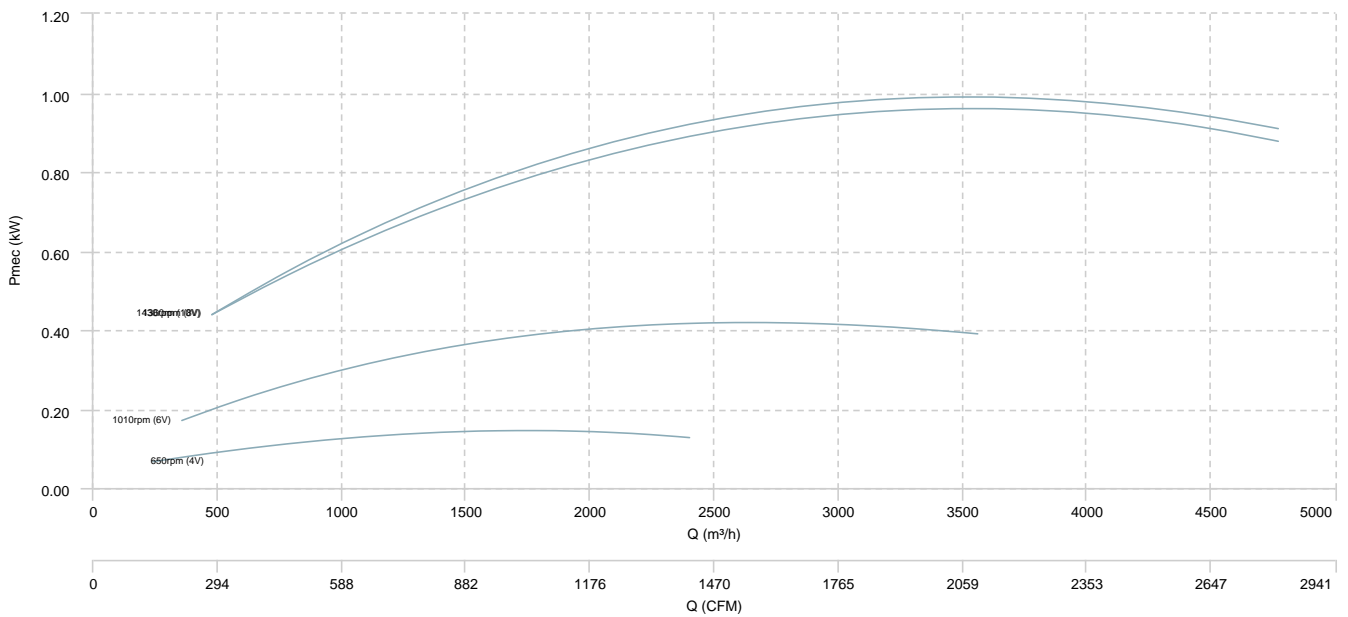

SBC-3 PLUS FILTER (ISO  
Coarse $\geq$ 60%+ePM1 $\geq$ 50%  
) 560 EEC

## AIR FLOW - PRESSURE

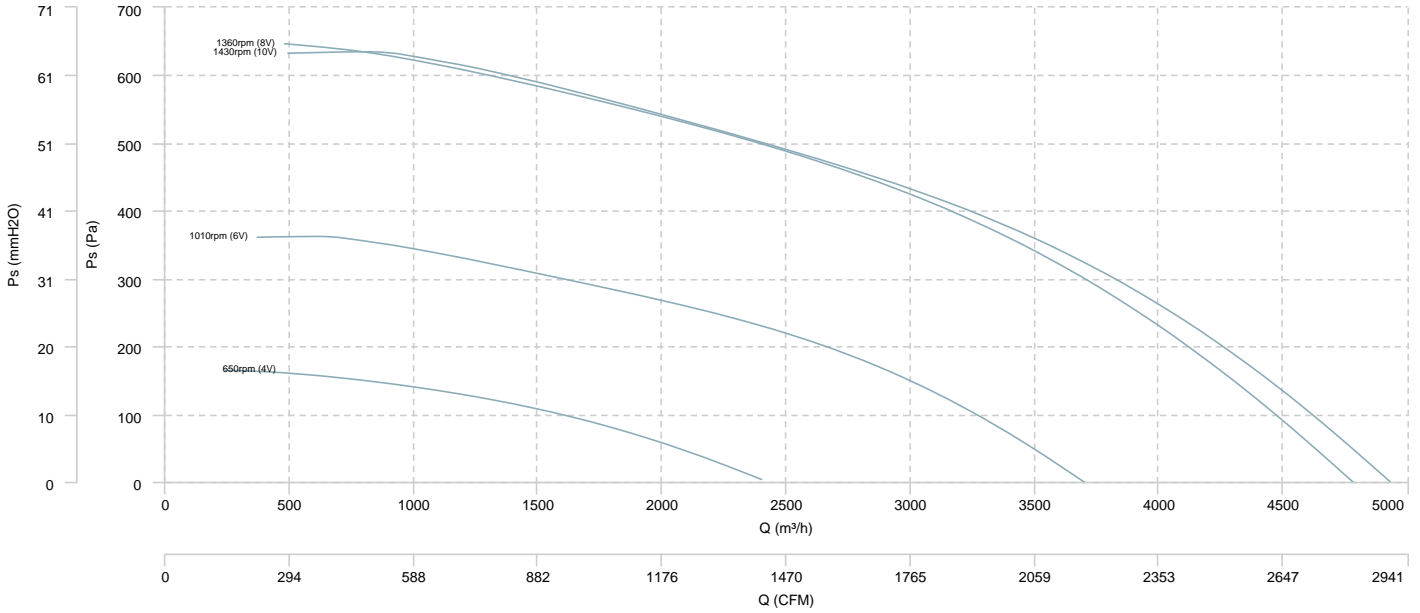

## AIR FLOW - MECHANICAL POWER

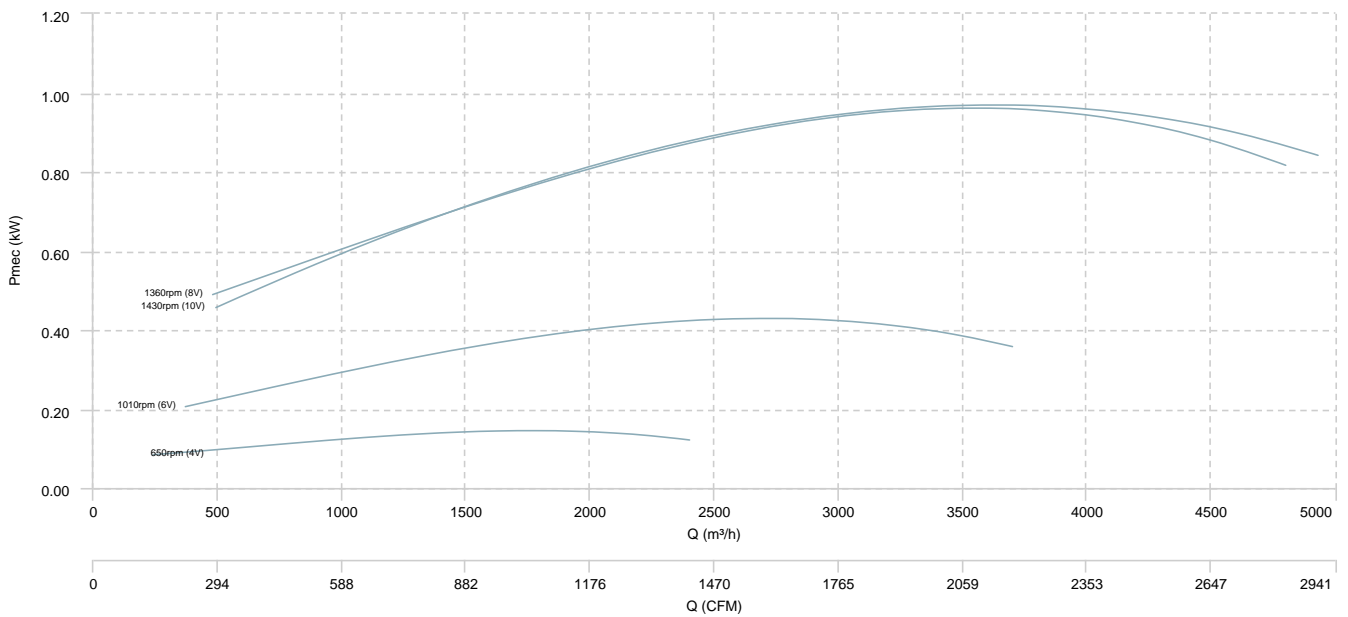

## Sound data

Sound power Lw dB (A)										
Model		63 Hz	125 Hz	250 Hz	500 Hz	1000 Hz	2000 Hz	4000 Hz	8000 Hz	Total
SBC-3 PLUS FILTER (ISO Coarse≥60%) 125 EEC (2270rpm (5V))	Radiated	-	22	12	29	41	46	51	41	52
SBC-3 PLUS FILTER (ISO Coarse≥60%) 150 EEC (2920rpm (7V))	Radiated	-	15	22	37	50	58	61	54	63
SBC-3 PLUS FILTER (ISO Coarse≥60%) 160 EEC (2050rpm (5V))	Radiated	-	7	14	29	42	50	53	46	55
SBC-3 PLUS FILTER (ISO Coarse≥60%) 200 EEC (2040rpm (7V))	Radiated	-	14	28	52	59	62	61	53	66
SBC-3 PLUS FILTER (ISO Coarse≥60%) 250 EEC (2040rpm (7V))	Radiated	-	14	28	52	59	62	61	53	66
SBC-3 PLUS FILTER (ISO Coarse≥60%) 315 EEC (1440rpm (5V))	Radiated	-	6	20	44	51	54	53	45	58
SBC-3 PLUS FILTER (ISO Coarse≥60%) 355 EEC (1920rpm (7V))	Radiated	-	11	30	46	56	57	52	44	61
SBC-3 PLUS FILTER (ISO Coarse≥60%) 400 EEC (1720rpm (7V))	Radiated	7	26	42	59	64	66	60	52	69
SBC-3 PLUS FILTER (ISO Coarse≥60%) 450 EEC (1720rpm (7V))	Radiated	7	26	42	59	64	66	60	52	69
SBC-3 PLUS FILTER (ISO Coarse≥60%) 500 EEC (1190rpm (7V))	Radiated	6	28	44	48	58	60	53	43	63
SBC-3 PLUS FILTER (ISO Coarse≥60%) 560 EEC (1190rpm (7V))	Radiated	6	28	44	48	58	60	53	43	63
SBC-3 PLUS FILTER (ISO Coarse≥60%+ePM1≥50%) 125 EEC (2270rpm (5V))	Radiated	-	22	12	29	41	46	51	41	52
SBC-3 PLUS FILTER (ISO Coarse≥60%+ePM1≥50%) 150 EEC (2920rpm (7V))	Radiated	-	15	22	37	50	58	61	54	63
SBC-3 PLUS FILTER (ISO Coarse≥60%+ePM1≥50%) 160 EEC (2050rpm (5V))	Radiated	-	7	14	29	42	50	53	46	55
SBC-3 PLUS FILTER (ISO Coarse≥60%+ePM1≥50%) 200 EEC (2040rpm (7V))	Radiated	-	14	28	52	59	62	61	53	66

Sound power Lw dB (A)										
Model		63 Hz	125 Hz	250 Hz	500 Hz	1000 Hz	2000 Hz	4000 Hz	8000 Hz	Total
SBC-3 PLUS FILTER (ISO Coarse≥60%+ePM1≥50%) 250 EEC (2040rpm (7V))	Radiated	-	14	28	52	59	62	61	53	66
SBC-3 PLUS FILTER (ISO Coarse≥60%+ePM1≥50%) 315 EEC (1440rpm (5V))	Radiated	-	6	20	44	51	54	53	45	58
SBC-3 PLUS FILTER (ISO Coarse≥60%+ePM1≥50%) 355 EEC (1920rpm (7V))	Radiated	-	11	30	46	56	57	52	44	61
SBC-3 PLUS FILTER (ISO Coarse≥60%+ePM1≥50%) 400 EEC (1720rpm (7V))	Radiated	7	26	42	59	64	66	60	52	69
SBC-3 PLUS FILTER (ISO Coarse≥60%+ePM1≥50%) 450 EEC (1720rpm (7V))	Radiated	7	26	42	59	64	66	60	52	69
SBC-3 PLUS FILTER (ISO Coarse≥60%+ePM1≥50%) 500 EEC (1190rpm (7V))	Radiated	6	28	44	48	58	60	53	43	63
SBC-3 PLUS FILTER (ISO Coarse≥60%+ePM1≥50%) 560 EEC (1190rpm (7V))	Radiated	6	28	44	48	58	60	53	43	63

**Notes:**

\* To calculate the sound power level at different rpm from those indicated above, use the following formula:

$$Lw \text{ dB(A)}_{rpmA} = Lw \text{ dB(A)}_{rpmB} + 52.5 \cdot \log_{10} \frac{rpmA}{rpmB}$$



## erp data

ERP	
Fan type	Unit for non-residential ventilation (LOT 6)
Typology	Static
Others	Outlet and Inlet free discharge
Type of driver	-

Model	Motor power (kW)	Maximum efficiency point data						
		Eff. Heat recovery (%)	Max. efficiency (%)	Pabs (kW)	Air Flow (m <sup>3</sup> /h)	Ps (Pa)	Speed (m/s)	SFP (W/m <sup>3</sup> /s)
SBC-3 PLUS FILTER (ISO Coarse≥60%) 200 EEC (2350rpm (8V))	0	-	32,84	0,19	489,33	468,79	4.33	1.435,26
SBC-3 PLUS FILTER (ISO Coarse≥60%) 200 EEC (2500rpm (10V))	0	-	32,70	0,19	474,47	472,31	4.2	1.435,26
SBC-3 PLUS FILTER (ISO Coarse≥60%) 250 EEC (2350rpm (8V))	0	-	33,89	0,22	691,28	379,17	3.91	1.098,83
SBC-3 PLUS FILTER (ISO Coarse≥60%) 250 EEC (2500rpm (10V))	0	-	34,39	0,22	706,40	375,49	4	1.098,83
SBC-3 PLUS FILTER (ISO Coarse≥60%) 315 EEC (2350rpm (8V))	0	-	41,28	0,21	820,42	376,18	2.92	902,12
SBC-3 PLUS FILTER (ISO Coarse≥60%) 315 EEC (2500rpm (10V))	0	-	41,66	0,21	844,27	379,40	3.01	902,12
SBC-3 PLUS FILTER (ISO Coarse≥60%) 355 EEC (1640rpm (6V))	0	-	41,53	0,20	888,88	334,46	2.49	1.463,21
SBC-3 PLUS FILTER (ISO Coarse≥60%) 355 EEC (2210rpm (8V))	0	-	41,37	0,45	1.112,19	599,40	3.12	1.463,21
SBC-3 PLUS FILTER (ISO Coarse≥60%) 355 EEC (2350rpm (10V))	0	-	43,81	0,45	1.098,62	647,42	3.08	1.463,21
SBC-3 PLUS FILTER (ISO Coarse≥60%) 400 EEC (1460rpm (6V))	0	-	43,12	0,33	1.448,79	352,61	3.2	1.555,07
SBC-3 PLUS FILTER (ISO Coarse≥60%) 400 EEC (1970rpm (8V))	0	-	45,72	0,78	1.955,46	652	4.32	1.555,07
SBC-3 PLUS FILTER (ISO Coarse≥60%) 400 EEC (2110rpm (10V))	0	-	40,90	0,80	1.850,52	624,35	4.09	1.555,07
SBC-3 PLUS FILTER (ISO Coarse≥60%) 450 EEC (1460rpm (6V))	0	-	42,31	0,34	1.613,77	304,28	2.82	1.333,29
SBC-3 PLUS FILTER (ISO Coarse≥60%) 450 EEC (1970rpm (8V))	0	-	42,98	0,87	2.173,99	600,14	3.8	1.333,29
SBC-3 PLUS FILTER (ISO Coarse≥60%) 450 EEC (2110rpm (10V))	0	-	47,33	0,88	2.380,70	612,21	4.16	1.333,29
SBC-3 PLUS FILTER (ISO Coarse≥60%) 500 EEC (650rpm (4V))	0	-	36,06	0,14	1.459,45	117,06	2.06	1.121,67
SBC-3 PLUS FILTER (ISO Coarse≥60%) 500 EEC (1010rpm (6V))	0	-	44,58	0,39	2.133,42	294,92	3.02	1.121,67

Model	Maximum efficiency point data							
	Motor power (kW)	Eff. Heat recovery (%)	Max. efficiency (%)	Pabs (kW)	Air Flow (m <sup>3</sup> /h)	Ps (Pa)	Speed (m/s)	SFP (W/m <sup>3</sup> /s)
SBC-3 PLUS FILTER (ISO Coarse≥60%) 500 EEC (1430rpm (10V))	0	-	46,40	0,91	2.910,35	512,72	4.12	1.121,67
SBC-3 PLUS FILTER (ISO Coarse≥60%) 560 EEC (1360rpm (8V))	1,01	-	46,61	0,91	3.003,30	491,69	3.39	1.052,09
SBC-3 PLUS FILTER (ISO Coarse≥60%) 560 EEC (650rpm (4V))	0	-	38,94	0,14	1.465,73	126,16	1.65	1.052,09
SBC-3 PLUS FILTER (ISO Coarse≥60%) 560 EEC (1010rpm (6V))	0	-	46,23	0,41	2.345,77	277,07	2.65	1.052,09
SBC-3 PLUS FILTER (ISO Coarse≥60%) 560 EEC (1430rpm (10V))	0	-	47,74	0,93	3.164,27	485,72	3.57	1.052,09
SBC-3 PLUS FILTER (ISO Coarse≥60%+ePM1≥50%) 315 EEC (2500rpm (10V))	0	-	32,41	0,21	674,76	361,03	2.41	1.123,25
SBC-3 PLUS FILTER (ISO Coarse≥60%+ePM1≥50%) 355 EEC (1640rpm (6V))	0	-	37,17	0,20	807,65	334,47	2.27	1.544,10
SBC-3 PLUS FILTER (ISO Coarse≥60%+ePM1≥50%) 355 EEC (2210rpm (8V))	0	-	38,32	0,45	1.010,70	617,16	2.84	1.544,10
SBC-3 PLUS FILTER (ISO Coarse≥60%+ePM1≥50%) 355 EEC (2350rpm (10V))	0	-	40,52	0,45	1.057,18	631,55	2.97	1.544,10